

Samurai

6 Port 10/100 Mbit/s Single Chip Ethernet Switch Controller (ADM6996FCX - Green Package Version; ADM6996FHX - Heat Sink and Green Package)

Version AD

Data Sheet

Revision 1.4

Communication Solutions



Never stop thinking

Edition 2006-03-24

**Published by
Infineon Technologies AG
81726 München, Germany**

**© Infineon Technologies AG 2006.
All Rights Reserved.**

Legal Disclaimer

The information given in this document shall in no event be regarded as a guarantee of conditions or characteristics ("Beschaffenhheitsgarantie"). With respect to any examples or hints given herein, any typical values stated herein and/or any information regarding the application of the device, Infineon Technologies hereby disclaims any and all warranties and liabilities of any kind, including without limitation warranties of non-infringement of intellectual property rights of any third party.

Information

For further information on technology, delivery terms and conditions and prices please contact your nearest Infineon Technologies Office (www.infineon.com).

Warnings

Due to technical requirements components may contain dangerous substances. For information on the types in question please contact your nearest Infineon Technologies Office.

Infineon Technologies Components may only be used in life-support devices or systems with the express written approval of Infineon Technologies, if a failure of such components can reasonably be expected to cause the failure of that life-support device or system, or to affect the safety or effectiveness of that device or system. Life support devices or systems are intended to be implanted in the human body, or to support and/or maintain and sustain and/or protect human life. If they fail, it is reasonable to assume that the health of the user or other persons may be endangered.

ADM6996FC/FCX/FHX, 6 Port 10/100 Mbit/s Single Chip Ethernet Switch Controller (ADM6996FCX - Green Package Version; ADM6996FHX - Heat Sink and Green Package)

Revision History: 2006-03-24, Revision 1.4

Previous Version: 1.1

Page/Date	Subjects (major changes since last revision)
	Rev. 1.15: Changed to Infineon format
Page12	Rev. 1.2: Modify analog pins number (RXP4-0, RXN4-0, TXP4-0 and TXN4-0)
Page 76-161	Rev. 1.21: Add 16bits mode registers description
Page21	Rev. 1.22: Modify LNKFP5 pin description/1 _B , Link Failed
2005-07-04	Changed to the new Infineon format
2005-08-30	Rev. 1.22 changed to Rev. 1.3 Update in content
2005-11-03	Revision 1.3 changed to Revision 1.31 Minor change. Included Green package information and Heat Sink information
2006-03-16	Revision 1.31 changed to Revision 1.4 Add 29 _H [10:9] register for BCTS and 29 _H [8] register for BPM Add thermal resistance information

Trademarks

ABM[®], AOP[®], BlueMoon[®], ConverGate[®], C166[®], DuSLIC[®], FALC[®], GEMINAX[®], INCA[®], IOM[®], IPVD[®], Isac[®], IWE[®], IWORX[®], MuSLIC[®], OCTALFALC[®], OCTAT[®], QUADFALC[®], SCOUT[®], SEROCCO[®], S-GOLD[®], SICOFI[®], SIEGET[®], SMARTI[®], SOCRATES[®], VINETIC[®], WDTC[®], 10BaseS[®] are registered trademarks of Infineon Technologies AG.

ACE[™], ARCOFI[™], ASM[™], ASP[™], BlueNIX[™], DigiTape[™], DUALFALC[™], EasyPort[™], E-GOLD[™], E-GOLDlite[™], EPIC[™], IPAT-2[™], ELIC[™], IDEC[™], ITAC[™], M-GOLD[™], SCT[™], S-GOLD2[™], S-GOLD3[™], MUSAC[™], POTSWIRE[™], QUAT[™], S-GOLDlite[™], SICAT[™], SIDEC[™], SLICOFI[™], VDSLite[™], 10BaseV[™], 10BaseVX[™] are trademarks of Infineon Technologies AG.

Microsoft[®] and Visio[®] are registered trademarks of Microsoft Corporation. Linux[®] is a registered trademark of Linus Torvalds. FrameMaker[®] is a registered trademark of Adobe Systems Incorporated. APOXI[®] is a registered trademark of Comneon GmbH & Co. OHG. PrimeCell[®], RealView[®], ARM[®] are registered trademarks of ARM Limited. OakDSPCore[®], TeakLite[®] DSP Core, OCEM[®] are registered trademarks of ParthusCeva Inc.

IndoorGPS[™], GL-20000[™], GL-LN-22[™] are trademarks of Global Locate. ARM926EJ-S[™], ADS[™], Multi-ICE[™] are trademarks of ARM Limited.

Table of Contents

1	Product Overview	10
1.1	Samurai - ADM6996FC/FCX/FHX Overview	10
1.2	Features	10
1.3	Applications	11
1.4	Block Diagram	11
2	Interface Description	13
2.1	Pin Diagram	13
2.2	Abbreviations	14
2.3	Pin Description by Function	14
3	Function Description	28
3.1	Functional Descriptions	28
3.2	10/100M PHY Block	28
3.3	100Base-X Module	28
3.4	100Base-X Receiver	28
3.4.1	A/D Converter	29
3.4.2	Adaptive Equalizer and timing Recovery Module	29
3.4.3	NRZI/NRZ and Serial/Parallel Decoder	29
3.4.4	Data De-scrambling	29
3.4.5	Symbol Alignment	29
3.4.6	Symbol Decoding	29
3.4.7	Valid Data Signal	30
3.4.8	Receive Errors	30
3.4.9	100Base-X Link Monitor	30
3.4.10	Carrier Sense	30
3.4.11	Bad SSD Detection	30
3.4.12	Far-End Fault	30
3.5	100Base-TX Transceiver	31
3.5.1	Transmit Drivers	31
3.5.2	Twisted-Pair Receiver	31
3.6	10Base-T Module	31
3.6.1	Operation Modes	31
3.6.2	Manchester Encoder/Decoder	31
3.6.3	Transmit Driver and Receiver	32
3.6.4	Smart Squelch	32
3.7	Carrier Sense	32
3.8	Jabber Function	32
3.9	Link Test Function	32
3.10	Automatic Link Polarity Detection	33
3.11	Clock Synthesizer	33
3.12	Auto Negotiation	33
3.13	Memory Block	33
3.14	Switch Functional Description	33
3.15	Basic Operation	34
3.15.1	Address Learning	34
3.15.2	Address Recognition and Packet Forwarding	34
3.15.3	Address Aging	34
3.15.4	Back off Algorithm	34
3.15.5	Inter-Packet Gap (IPG)	35
3.15.6	Illegal Frames	35
3.15.7	Half Duplex Flow Control	35
3.15.8	Full Duplex Flow Control	35
3.15.9	Old Broadcast Storm filter (0x0b[0]=0 and 0x11[6]=0)	35

Table of Contents

3.15.10	New Broadcast/Multicast Storm (0x0b[0]=1 and 0x11[6]=1)	36
3.16	Auto TP MDIX Function	36
3.17	Port Locking	36
3.18	VLAN setting & Tag/Untag & port-base VLAN	36
3.19	Old Fixed Ingress Bandwidth Control (0x0b[0]=0)	37
3.20	New Scalable Egress/Ingress Bandwidth Control (0x0b[0]=1 and 0x33[12]=1)	37
3.21	MAC Table Accessible	37
3.22	Priority Setting	38
3.23	LED Display	38
3.23.1	Single Color LED Display	39
3.23.2	Dual Color LED Display	41
3.23.3	Circuit for Single LED Mode	41
3.23.4	Circuit for Dual Led Mode	42
3.24	Port4 and Port5 MII connection	42
3.25	The Hardware Difference between ADM6996FC/FCX and ADM6996F	47
4	Registers Description	48
4.1	EEPROM Register (0x0b[0]=0)	48
4.1.1	EEPROM Contents	50
4.2	Serial Register	70
4.2.1	Serial Register Map	71
4.3	Packet with Priority: Normal packet content	78
4.4	VLAN Packet	78
4.5	TOS IP Packet	79
4.6	EEPROM Access	79
4.7	Serial Interface Timing	81
5	16 Bits Mode Registers Description	86
5.1	EEPROM Basic Registers	97
5.2	EEPROM Extended Registers	131
5.3	Counter and Switch Status Registers	141
5.4	PHY Registers	158
6	Electrical Specification	169
6.1	TX/FX Interface	169
6.1.1	TP Interface	169
6.1.2	FX Interface	170
6.2	DC Characterization	170
6.3	AC Characterization	172
6.3.1	XTAL/OSC Timing	172
6.3.2	Power On Reset	173
6.3.3	EEPROM Interface Timing	173
6.3.4	10Base-TX MII Input Timing	174
6.3.5	10Base-TX MII Output Timing	176
6.3.6	100Base-TX MII Input Timing	177
6.3.7	100Base-TX MII Output Timing	178
6.3.8	RMII REFCLK Input Timing	178
6.3.9	RMII REFCLK Output Timing	179
6.3.10	Reduce MII Timing	180
6.3.11	GPSI (7-wire) Input Timing	181
6.3.12	GPSI (7-wire) Output Timing	182
6.3.13	SDC/SDIO Timing	182
6.3.14	MDC/MDIO Timing	183
7	Package Outlines	184

7.1 Package Information 184

List of Figures

Figure 1	ADM6996FC/FCX/FHX Block Diagram	12
Figure 2	4 TP/FX PORT + 2 MII PORT 128 Pin Diagram.....	13
Figure 3	Circuit for Single Color LED Mode	41
Figure 4	Circuit for Dual Color LED Mode	42
Figure 5	ADM6996FC/FCX to CPU with single MII connection	43
Figure 6	ADM6996FC/FCX to CPU with dual MII connection.....	44
Figure 7	MAC Clone Enable and VLAN Setting	45
Figure 8	100M Full duplex MAC to MAC MII connection	46
Figure 9	PCS to MAC MII connection.....	47
Figure 10	Old Router Architecture Example	57
Figure 11	New Router Architecture Using ADM6996FC/FCX/FHX	58
Figure 12	CPU Generated Reset Signal Requirement.....	80
Figure 13	CPU Write EEPROM Command Requirement.....	80
Figure 14	Serial Interface Read Command Timing.....	81
Figure 15	Serial Interface Reset Command Timing	82
Figure 16	TP Interface	169
Figure 17	FX Interface	170
Figure 18	XTAL/OSC Timing	172
Figure 19	Power On Reset Timing	173
Figure 20	EEPROM Interface Timing	174
Figure 21	10Base-TX MII Input Timing.....	175
Figure 22	10Base-TX MII Output Timing	176
Figure 23	100Base-TX MII Input Timing.....	177
Figure 24	100Base-TX MII Output Timing	178
Figure 25	RMII REFCLK Input Timing	178
Figure 26	RMII REFCLK Output Timing	179
Figure 27	Reduce MII Timing (1 of 2).....	180
Figure 28	Reduce MII Timing (2 of 2).....	180
Figure 29	GPSI (7-wire) Input Timing.....	181
Figure 30	GPSI (7-wire) Output Timing	182
Figure 31	SDC/SDIO Timing.....	182
Figure 32	MDC/MDIO Timing	183
Figure 33	P-PQFP-128 Outside Dimension	184

List of Tables

Table 1	Abbreviations for Pin Type	14
Table 2	Abbreviations for Buffer Type	14
Table 3	IO Signals	15
Table 4	The max. packet number = 7490 in 100Base, 749 in 10Base	35
Table 5	The max. packet number = 7490 in 100Base, 749 in 10Base	35
Table 6	Fixed Ingress Bandwidth Control	37
Table 7	Single Color LED Display	39
Table 8	Dual Color LED Display	41
Table 9	Pin Description(QFP128)	47
Table 10	Registers Address Space	48
Table 11	Registers Overview	48
Table 12	Register Access Types	49
Table 13	Registers Clock Domains	50
Table 14	Basic Control Registers 1 to 4	52
Table 15	Reserved Register 1 to 3	52
Table 16	Reserved Register 6	54
Table 17	The max. packet number = 7490 in 100Base, 749 in 10Base	56
Table 18	The max. packet number = 7490 in 100Base, 749 in 10Base	56
Table 19	Drop Scheme for Each Queue	56
Table 20	Basic Control Registers 1 to 4	61
Table 21	Reserved Register 8 to 11	62
Table 22	Note: Reference Table	67
Table 23	Registers Address Space	70
Table 24	Registers Overview	70
Table 25	Registers Clock Domains	71
Table 26	Per Port Counter	75
Table 27	Ethernet Packet from Layer 2	78
Table 28	VLAN Packet	79
Table 29	IP Packet	79
Table 30	RESETL & EEPROM Content Relationship	79
Table 31	Registers Overview	83
Table 32	Broadcast Storming Threshold	86
Table 33	Priority Queue Weight Ratio	86
Table 34	Registers Address Space	87
Table 35	Registers Overview	87
Table 36	Register Access Types	95
Table 37	Registers Clock Domains	96
Table 38	Basic Control Registers 1 to 5	98
Table 39	Reserved Registers	99
Table 40	PxSO Registers	108
Table 41	VFxL Registers	131
Table 42	VFxH Registers	132
Table 43	TFx Registers	133
Table 44	PFx Registers	134
Table 45	TUFx Registers	135
Table 46	CLx Registers	144
Table 47	CHx Registers	146
Table 48	PHY_Cx Registers	160
Table 49	PHY_Sx Registers	162

List of Tables

Table 50	PHY_Ix_A Registers	162
Table 51	PHY_Ix_B Registers	163
Table 52	ANAPx Registers	164
Table 53	ANLPx Registers	165
Table 54	ANEx Registers	166
Table 55	NPTx Registers	167
Table 56	LPNPx Registers	168
Table 57	Power Consumption	170
Table 58	Absolute Maximum Ratings	171
Table 59	Recommended Operating Conditions	171
Table 60	DC Electrical Characteristics for 3.3 V Operation	172
Table 61	XTAL/OSC Timing	173
Table 62	Power On Reset Timing	173
Table 63	EEPROM Interface Timing	174
Table 64	10Base-TX MII Input Timing	175
Table 65	10-Base-TX MII Output Timing	176
Table 66	100Base-TX MII Input Timing	177
Table 67	100Base-TX MII Output Timing	178
Table 68	RMII REFCLK Input Timing	179
Table 69	RMII REFCLK Output Timing	179
Table 70	Reduce MII Timing	180
Table 71	GPSI (7-wire) Input Timing	181
Table 72	GPSI (7-wire) Output Timing	182
Table 73	SDC/SDIO Timing	183
Table 74	MDC/MDIO Timing	183

1 Product Overview

1.1 Samurai - ADM6996FC/FCX/FHX Overview

The Samurai - ADM6996FC/FCX/FHX is a high performance, low cost, highly integrated (Controller, PHY and Memory) switch controller with five 10M/100M auto-detect Half/Full duplex switch ports with TX/FX interfaces with one of these ports also an MII and one dedicated MII/GPSI port. The ADM6996FCX is the environmentally friendly package or 'green' package. The FH solution contains a heat sink which can be used in special circumstances but is not recommended for all projects. The ADM6996FC/FCX/FHX is intended for applications such as stand alone bridges for the low cost SOHO markets such as 5-port switches and router applications.

The ADM6996FC/FCX/FHX provides functions such as: 802.1p(Q.O.S.), Port-based/Tag-based VLAN, Port MAC address locking, management, port status, TP auto-MDIX, 25M crystal & extra MII port functions to meet customer requests on switch demand.

The ADM6996FC/FCX/FHX also supports back pressure in Half-Duplex mode and the 802.3x Flow Control Pause packet in Full-Duplex mode to prevent packet loss when buffers are full. When Back Pressure is enabled, and there is no receive buffer available for the incoming packet, the ADM6996FC/FCX/FHX will issue a JAM pattern on the receiving port in Half Duplex mode and issue the 802.3x Pause packet back to the receiving end in Full Duplex mode.

The built-in SRAM used for the packet buffer is divided into 256 bytes per block to achieve the optimized memory utilization through complicated link lists on packets with various lengths.

The ADM6996FC/FCX/FHX also supports priority features using Port-Based, VLAN and IP TOS field checking. Users can easily set different priority modes in individual ports, through a small low-cost micro controller when initializing or configure on-the-fly. Each output port supports four queues in the way of fixed 8:4:2:1 fairness queuing to fit the bandwidth demand on various types of packets such as Voice, Video and Data. Tag/Untag, and up to 16 groups of VLAN are also supported.

An intelligent address recognition algorithm allows ADM6996FC/FCX/FHX to recognize up to 2K different MAC addresses and enables filtering and forwarding at full wire speed.

Port MAC address Locking function is also supported by ADM6996FC/FCX/FHX to use on building Internet access to prevent multiple users sharing one port.

1.2 Features

- Supports four 10M/100M auto-detect Half/Full duplex switch ports with TX/FX interfaces and two MII port with one of these MII ports supporting MII/GPSI
- Supports four 10M/100M auto-detect Half/Full duplex switch ports with TX/FX interfaces, one MII port (for CPU LAN MII) and one isolated PHY(for CPU WAN MII).
- Supports 2K MAC addresses table with 4-ways associative hash algorithm.
- 6KX64 bits packet buffers are divided into 192 blocks of 256 bytes each
- Supports four queue for QoS
- Supports priority features by Port-Based, 802.1p, IP TOS of packets.
- Store & Forward architecture and performs forwarding and filtering at non-blocking full wire speed.
- Supports buffer allocation with 256 bytes per block
- Aging function Enable/Disable.
- Supports per port Single/Dual color mode with Power On auto diagnostic.
- 802.3x Flow Control pause packet for Full Duplex in case buffer is full.
- Back Pressure function for Half Duplex operation in case buffer is full.
- Supports packet length up to 1518/1522 (Default)/1536/1784 bytes in maximum.
- Broadcast/Multicast Storm Suppression.

- Tag-based VLAN. Up to 16 VLAN groups are implemented by the last four bits of VLAN ID.
- 2bit MAC clone to support multiple WAN application
- Supports TP interface Auto MDIX function for auto TX/RX swap by strapping-pin.
- Easy Management 32bits smart counter for per port RX/TX byte/packet count, 16-bit smart counter for per port ERROR count and Collision count.
- Supports PHY status output for management system.
- 25M Crystal only for the whole system.
- 128 QFP package with 0.18um technology. 1.8 V/3.3 V power supply.
- 1.0 W low power consumption.

1.3 Applications

ADM6996FC/FCX/FHX:

- SOHO 5-port switch
- 5-port switch + Router with MII CPU interface.

1.4 Block Diagram

Figure 1 below shows a simple block diagram of the ADM6996FC/FCX/FHX internal blocks.

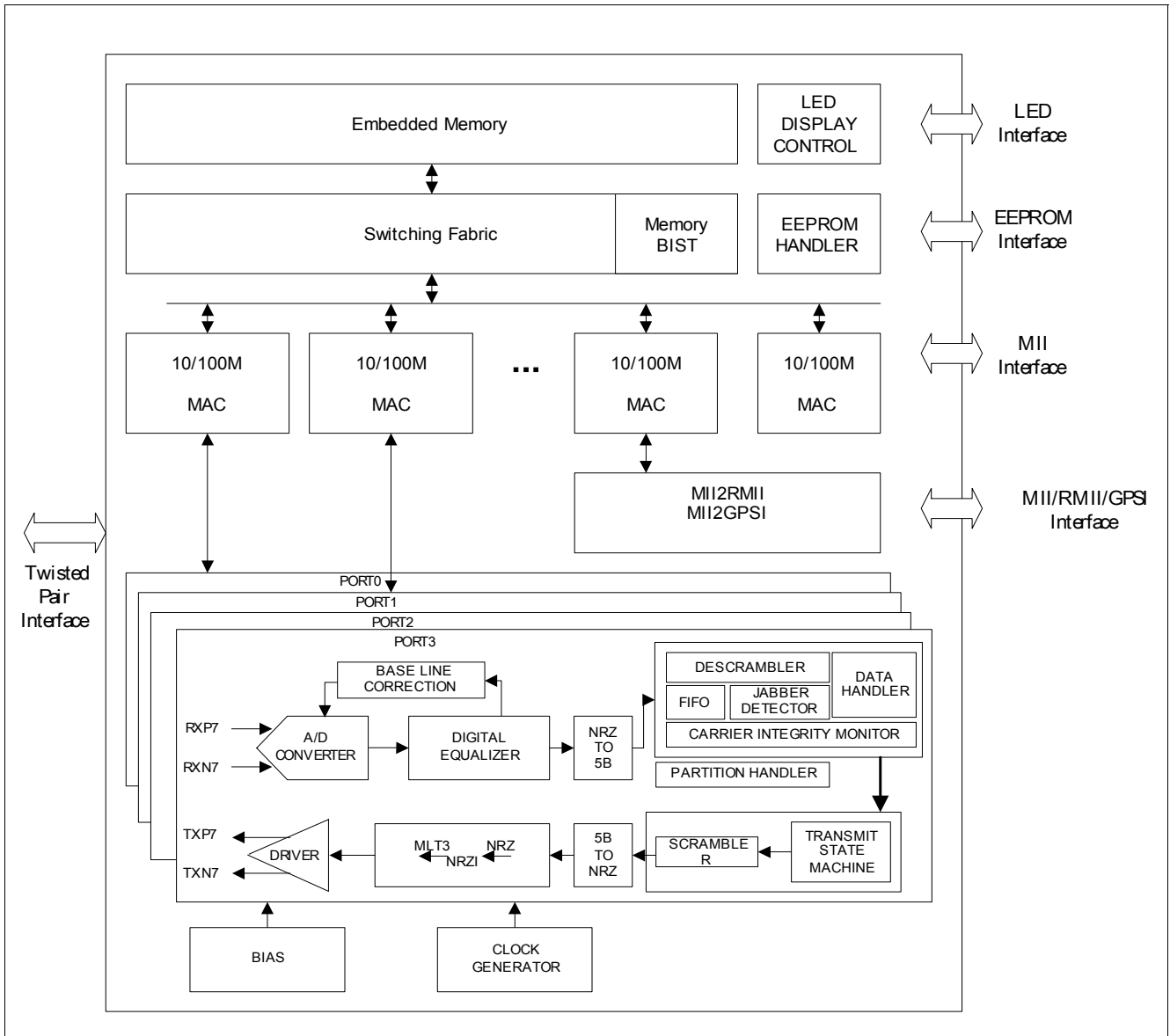

Figure 1 ADM6996FC/FCX/FHX Block Diagram

2 Interface Description

This chapter describes the interface descriptions for the ADM6996FC/FCX/FHX

- Pin Diagram
- Abbreviations
- Pin Description by Function

2.1 Pin Diagram

Figure 2 shows the pin diagram for the ADM6996FC/FCX/FHX.

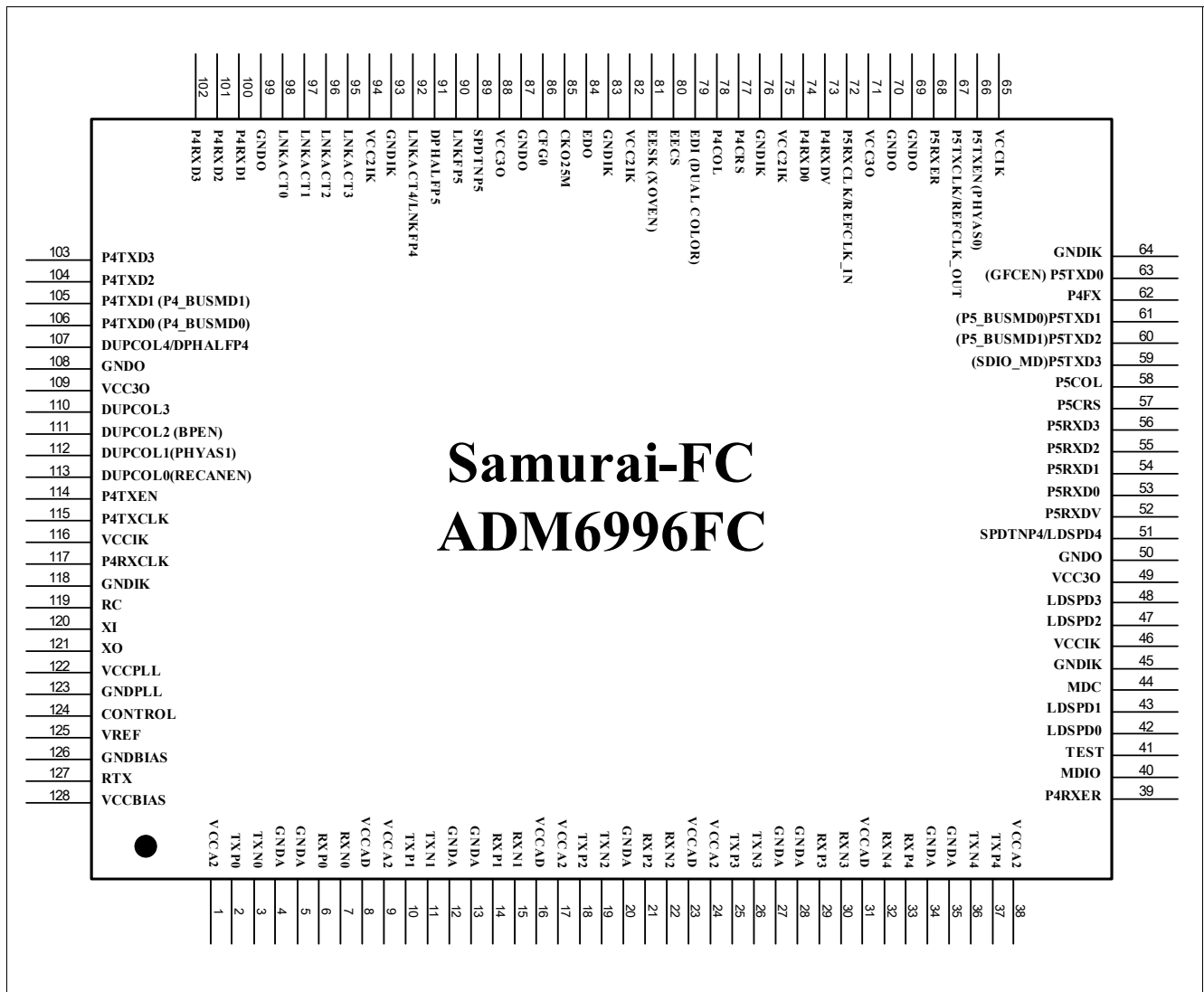

Figure 2 4 TP/FX PORT + 2 MII PORT 128 Pin Diagram

2.2 Abbreviations

Standard abbreviations for I/O tables:

Table 1 Abbreviations for Pin Type

Abbreviations	Description
I	Standard input-only pin. Digital levels.
O	Output. Digital levels.
I/O	I/O is a bidirectional input/output signal.
AI	Input. Analog levels.
AO	Output. Analog levels.
AI/O	Input or Output. Analog levels.
PWR	Power
GND	Ground
MCL	Must be connected to Low (JEDEC Standard)
MCH	Must be connected to High (JEDEC Standard)
NU	Not Usable (JEDEC Standard)
NC	Not Connected (JEDEC Standard)

Table 2 Abbreviations for Buffer Type

Abbreviations	Description
Z	High impedance
PU	Pull up, 10 k Ω
PD	Pull down, 10 k Ω
TS	Tristate capability: The corresponding pin has 3 operational states: Low, high and high-impedance.
OD	Open Drain. The corresponding pin has 2 operational states, active low and tristate, and allows multiple devices to share as a wire-OR. An external pull-up is required to sustain the inactive state until another agent drives it, and must be provided by the central resource.
OC	Open Collector
PP	Push-Pull. The corresponding pin has 2 operational states: Active-low and active-high (identical to output with no type attribute).
OD/PP	Open-Drain or Push-Pull. The corresponding pin can be configured either as an output with the OD attribute or as an output with the PP attribute.
ST	Schmitt-Trigger characteristics
TTL	TTL characteristics

2.3 Pin Description by Function

ADM6996FC/FCX/FHX pins are categorized into one of the following groups:

- Network Media Connection
- Port 4 MII Interface
- Port 5 MII Interface
- LED Interface
- EEPROM Interface
- Power/Ground, 48 pins
- Miscellaneous

Note: [Table 1](#) can be used for reference.

Table 3 IO Signals

Ball No.	Name	Pin Type	Buffer Type	Function
Network Media Connection				
33	RXP_4	AI/O	ANA	Receive Pair Differential data is received on this pin.
29	RXP_3			
21	RXP_2			
14	RXP_1			
6	RXP_0			
32	RXN_4	AI/O	ANA	
30	RXN_3			
22	RXN_2			
15	RXN_1			
7	RXN_0			
37	TXP_4	AI/O	ANA	Transmit Pair Differential data is transmitted on this pin.
25	TXP_3			
18	TXP_2			
10	TXP_1			
2	TXP_0			
36	TXN_4	AI/O	ANA	
26	TXN_3			
19	TXN_2			
11	TXN_1			
3	TXN_0			
Port 4 MII Interface				
74	MMII_P4RXD0	I	PD, LVTTTL	Port 4 Receive Data Bit 0 in MAC MII Mode In MAC MII mode, the bit is the LSB of MII receive data, synchronous to the rising edge of MMII_P4RXCLK.
	PMII_P4RXD0	O	8 mA, PD, LVTTTL	Port 4 Receive Data Bit 0 in PCS MII Mode When port 4 is operating in PCS MII mode, the bit is the LSB of MII receive data output and synchronous to the rising edge of PMII_P4RXCLK.
102	MMII_P4RXD3	I	PD, LVTTTL	Port 4 Receive Data Bit 3 in MAC MII Mode In MAC MII mode, this bit is bit[3] of MII receive data, and synchronous to the rising edge of MMII_P4RXCLK.
	PMII_P4RXD3	O	8 mA, PD, LVTTTL	Port 4 Receive Data Bit 3 in PCS MII Mode When port 4 is operating in PCS MII mode, this pin is bit[3] of MII receive data output and synchronous to the rising edge of PMII_P4RXCLK.

Table 3 IO Signals (cont'd)

Ball No.	Name	Pin Type	Buffer Type	Function
101	MMII_P4RXD2	I	PD, LVTTTL	Port 4 Receive Data Bit 2 in MAC MII Mode In MAC MII mode, this pin is bit[2] of MII receive data, and synchronous to the rising edge of MMII_P4RXCLK.
	PMII_P4RXD2	O	8 mA, PD, LVTTTL	Port 4 Receive Data Bit 2 in PCS MII Mode When port 4 is operating in PCS MII mode, this pin is bit[2] of MII receive data output and synchronous to the rising edge of PMII_P4RXCLK.
100	MMII_P4RXD1	I	PD, LVTTTL	Port 4 Receive Data Bit 1 in MAC MII Mode In MAC MII mode, this pin is bit[1] of MII receive data, and synchronous to the rising edge of MMII_P4RXCLK.
	PMII_P4RXD1	O	8 mA, PD, LVTTTL	Port 4 Receive Data Bit 1 in PCS MII Mode When port 4 is operating in PCS MII mode, this pin is bit[1] of MII receive data output and synchronous to the rising edge of PMII_P4RXCLK.
73	MMII_P4RXDV	I	PD, LVTTTL	Port 4 Receive Data Valid in MAC MII Mode Active high to indicate that the data on MMII_P4RXD[3:0] is valid. Synchronous to the rising edge of MMII_P4RXCLK.
	PMII_P4RXDV	O	8 mA, PD, LVTTTL	Port 4 Receive Data Valid in PCS MII Mode When port 4 is operating in PCS MII mode, this pin is an active high output signal to indicate PMII_P4RXD[3:0] is valid. Synchronous to the rising edge of PMII_P4RXCLK.
39	MII_P4RXER	I	PD, LVTTTL	Port 4 Receive Error in MAC MII Mode Active high to indicate that there is symbol error on the MII_P4RXD [3:0]. Only valid in 100M operation.
77	MMII_P4CRS	I	PD, LVTTTL	Port 4 Carrier Sense in MAC MII Mode In full duplex mode, MMII_P4CRS reflects the receive carrier sense situation on medium only; In Half Duplex, CRS will be high both in receive and transmit condition.
	PMII_P4CRS	O	8 mA, PD, LVTTTL	Port 4 Carrier Sense in PCS MII Mode When port 4 is operating in PCS MII mode, this pin is used to output Carrier Sense status.
78	MMII_P4COL	I	PD, LVTTTL	Port 4 Collision input in MAC MII Mode Active high to indicate that there is collision on the medium. Stay low in full duplex operation.
	PMII_P4COL	O	8 mA, PD, LVTTTL	Port 4 Collision output in PCS MII Mode When port 4 is operating in PCS MII mode, this pin is used to output collision status.

Table 3 IO Signals (cont'd)

Ball No.	Name	Pin Type	Buffer Type	Function
106	P4_BUSMD0	I	PD, LVTTTL	Port 4 Bus Type Configuration 0 Value on this pin will be latched by ADM6996FC/FCX/FHX at the rising edge of RESETL(RC) for Port 4 Configuration Bit 0. Combined with CFG0 and P4_BUSMD1 , ADM6996FC/FCX/FHX provides 4 bus type for port 4. See CFG0 pin description for more detail. <i>Note: Power On Setting</i>
	MMII_P4TXD0	O	8 mA, PD, LVTTTL	Port 4 Transmit Data Bit 0 in MAC MII Mode The LSB bit of MAC MII Transmit data of port 4. Synchronous to the rising edge of MMII_P4TXCLK.
	PMII_P4TXD0	I	PD, LVTTTL	Port 4 Transmit Data Bit 0 in PCS MII Mode When port 4 is operating in PCS MII mode, this pin is the LSB of MII transmit data input and synchronous to the rising edge of PMII_P4TXCLK.
105	P4_BUSMD1	I	PD, LVTTTL	Port 4 Bus Type Configuration 1 Value on this pin will be latched by ADM6996FC/FCX/FHX at the rising edge of RESETL(RC) for Port 4 Configuration Bit 1. Combined with CFG0 and P4_BUSMD0 , ADM6996FC/FCX/FHX provides 4 bus type for port 4. See CFG0 for more detail. <i>Note: Power On Setting</i>
	MMII_P4TXD1	O	8 mA, PD, LVTTTL	Port 4 Transmit Data Bit 1 in MAC MII Mode The bit[1] of MAC MII Transmit data of port 4. Synchronous to the rising edge of MMII_P4TXCLK.
	PMII_P4TXD1	I	PD, LVTTTL	Port 4 Transmit Data Bit 1 in PCS MII Mode When port 4 is operating in PCS MII mode, this pin is bit[1] of MII transmit data input and synchronous to the rising edge of PMII_P4TXCLK.
103	MMII_P4TXD3	O	8 mA, PD, LVTTTL	Port 4 Transmit Data Bit 3 in MAC MII Mode The bit[3] of MAC MII Transmit data of port 4. Synchronous to the rising edge of MMII_P4TXCLK.
	PMII_P4TXD3	I	PD, LVTTTL	Port 4 Transmit Data Bit 3 in PCS MII Mode When port 4 is operating in PCS MII mode, this pin is bit[3] of MII transmit data input and synchronous to the rising edge of PMII_P4TXCLK.
104	MMII_P4TXD2	O	8 mA, PD, LVTTTL	Port 4 Transmit Data Bit 2 in MAC MII Mode The bit [2] of MAC MII Transmit data of port 4. Synchronous to the rising edge of MMII_P4TXCLK.
	PMII_P4TXD2	I	PD, LVTTTL	Port 4 Transmit Data Bit 2 in PCS MII Mode When port 4 is operating in PCS MII mode, this pin is bit[2] of MII transmit data input and synchronous to the rising edge of PMII_P4TXCLK.

Table 3 IO Signals (cont'd)

Ball No.	Name	Pin Type	Buffer Type	Function
114	MMII_P4TXEN	O	8 mA, PD, LVTTTL	Port 4 Transmit Enable in MAC MII Mode Output by ADM6996FC/FCX/FHX at the rising edge of MMII_P4TXCLK when ADM6996FC/FCX/FHX is programmed to MAC Type MII.
	PMII_P4TXEN	I	PD, LVTTTL	Port 4 Transmit Enable in PCS MII Mode It is the MII Transmit Enable input to ADM6996FC/FCX/FHX when programmed to PCS Type MII.
117	MMII_P4RXCLK	I	PD, LVTTTL	Port 4 Receive Clock in MAC MII Mode 25MHz Free Running clock in 100M Mode and 2.5 MHz free running clock in 10M Mode. MMII_P4RXDV and MMII_P4RXD[3:0] should be synchronous to the rising edge of this clock
	PMII_P4RXCLK	O	8 mA, PD, LVTTTL	Port 4 Receive Clock in PCS MII Mode 25MHz Free Running clock in 100M Mode and 2.5 MHz free running clock in 10M Mode. PMII_P4RXDV and PMII_P4RXD[3:0] should be synchronous to the rising edge of this clock
115	MMII_P4TXCLK	I	PD, LVTTTL	Port 4 Transmit Clock in MAC MII Mode 25MHz Free Running clock in 100M Mode and 2.5 MHz free running clock in 10M Mode. MMII_P4TXEN and MMII_P4TXD[3:0] should be synchronous to the rising edge of this clock
	PMII_P4TXCLK	O	8 mA, PD, LVTTTL	Port 4 Transmit Clock in PCS MII Mode 25MHz Free Running clock in 100M Mode and 2.5 MHz free running clock in 10M Mode. PMII_P4TXEN and PMII_P4TXD[3:0] should be synchronous to the rising edge of this clock
62	P4FX	I	PD, LVTTTL	Port 4 Fiber Selection for PCS MII/PHY mode During power on reset, value will be latched by ADM6996FC/FCX/FHX at the rising edge of RESETL(RC) as port 4 Fiber select. 0 _B Twisted Pair Mode 1 _B Fiber Mode

Port 5 MII Interface

Table 3 IO Signals (cont'd)

Ball No.	Name	Pin Type	Buffer Type	Function
63	GFCEN	I	PU, LVTTTL	<p>Global Flow Control Enable Value on this pin will be latched by ADM6996FC/FCX/FHX at the rising edge of RESETL(RC) as Flow control enable. <i>Note: Power On Setting</i></p> <p>0_B Flow Control Capability is depended upon the register setting in corresponding port's Basic Control Register 1_B All ports flow control capability is enabled</p>
	MII_P5TXD0	O	4 mA, PU, LVTTTL	<p>Port 5 Transmit Data Bit 0 in MII Mode The LSB bit of MII Transmit data of port 5. Synchronous to the rising edge of MII_P5TXCLK.</p>
	GPSI_P5TXD	O	4 mA, PU, LVTTTL	<p>Port 5 Transmit Data in GPSI Mode When port 5 is operating in GPSI mode, this pin acts as GPSI Transmit Data. Synchronous to the rising edge of GPSI_P5TXCLK.</p>
	RMII_P5TXD0	O	4 mA, PU, LVTTTL	<p>Port 5 Transmit Data Bit 0 in RMII Mode When port 5 is operating in RMII mode, this pin acts as RMII Transmit Data Bit [0]. Synchronous to the rising edge of REFCLK_IN.</p>
61	P5_BUSMD0	I	PD, LVTTTL	<p>Port 5 Bus Mode Selection Bit 0 Value on this pin will be latched by ADM6996FC/FCX/FHX at the rising edge of RESETL(RC) as port 5 bus mode selection bit 0. Combined with P5_BUSMD1, ADM6996FC/FCX/FHX provides 3 bus types for port 5. P5_BUSMD[1:0], Interface <i>Note: Power On Setting</i></p> <p>00_B MII 01_B GPSI 10_B RMII 11_B Reserved and not allowed</p>
	MII_P5TXD1	O	4 mA, PD, LVTTTL	<p>Port 5 Transmit Data Bit 1 in MII Mode The Second bit of MII Transmit data of port 5. Synchronous to the rising edge of MII_P5TXCLK.</p>
	RMII_P5TXD1	O	4 mA, PD, LVTTTL	<p>Port 5 Transmit Data Bit 1 in RMII Mode The Second bit of RMII Transmit data of port 5. Synchronous to the rising edge of REFCLK_IN.</p>
60	P5_BUSMD1	I	PD, LVTTTL	<p>Port 5 Bus Mode Selection Bit 1 Value on this pin will be latched by ADM6996FC/FCX/FHX at the rising edge of RESETL(RC) as port 5 bus mode selection bit 1. See P5_BUSMD0 for more details. <i>Note: Power On Setting</i></p>
	MII_P5TXD2	O	4 mA, PD, LVTTTL	<p>Port 5 Transmit Data Bit 2 in MII Mode The Third bit of MII Transmit data of port 5. Synchronous to the rising edge of MII_P5TXCLK.</p>

Table 3 IO Signals (cont'd)

Ball No.	Name	Pin Type	Buffer Type	Function
59	SDIO_MD	I	PD, LVTTTL	SDC/SDIO Mode Selection Value on this pin will be latched by ADM6996FC/FCX/FHX at the rising edge of RESETL (RC) for SDIO 32/16 bits selection. 0_B 32 Bits Mode 1_B 16 Bits Mode. Same timing as MDC/MDIO.
	MII_P5TXD3	O	4 mA, PD, LVTTTL	Port 5 Transmit Data Bit 3 in MII Mode The MSB bit of MII Transmit data of port 5. Synchronous to the rising edge of MII_P5TXCLK.
66	PHYAS0	I	PD, LVTTTL	PHY Address MSB Bit 0 During power on reset, value will be latched by ADM6996FC/FCX/FHX at the rising edge of RESETL(RC) as PHY starts address select. PHYAS[1:0] = 00_B and PHY address start from 01000_B <i>Note: Power On Setting</i>
	MII_P5TXEN	O	8 mA, PD, LVTTTL	Port 5 Transmit Enable TXEN in MII Mode Active high to indicate that the data on MII_P5TXD[3:0] is valid. Synchronous to the rising edge of MII_P5TXCLK.
	GPSI_P5TXEN	O	8 mA, PD, LVTTTL	Port 5 Transmit Enable TXEN in GPSI Mode Active high to indicate that the data on GPSI_P5TXD is valid. Synchronous to the rising edge of GPSI_P5TXCLK.
	RMII_P5TXEN	O	8 mA, PD, LVTTTL	Port 5 Transmit Enable TXEN in RMII Mode Active high to indicate that the data on RMII_P5TXD[1:0] is valid. Synchronous to the rising edge of REFCLK_IN.
53	MII_P5RXD0	I	PD, LVTTTL	Port 5 Receive Data Bit 0 in MII Mode In MII mode, the bit is the LSB of MII receive data, synchronous to the rising edge of MII_P5RXCLK.
	GPSI_P5RXD	I	PD, LVTTTL	Port 5 Receive Data in GPSI Mode In GPSI Mode, this acts as Receive Data Input, synchronous to the rising edge of GPSI_P5RXCLK.
	RMII_P5RXD0	I	PD, LVTTTL	Port 5 Receive Data Bit 0 in RMII Mode In RMII mode, the bit is the LSB of RMII receive data, synchronous to the rising edge of REFCLK_IN.
54	MII_P5RXD1	I	PD, LVTTTL	Port 5 Receive Data Bit 1 in MII Mode In MII mode, the bit is the LSB of MII receive data, synchronous to the rising edge of MII_P5RXCLK.
	RMII_P5RXD1	I	PD, LVTTTL	Port 5 Receive Data Bit 1 in RMII Mode In RMII mode, the bit is the MSB of RMII receive data, synchronous to the rising edge of REFCLK_IN.
55	MII_P5RXD2	I	PD, LVTTTL	Port 5 Receive Data Bit 2 in MII Mode In MII mode, the bit is the bit[2] of MII receive data. Synchronous to the rising edge of MII_P5RXCLK.
56	MII_P5RXD3	I	PD, LVTTTL	Port 5 Receive Data Bit 3 in MII Mode In MII mode, the bit is the bit[3] of MII receive data. Synchronous to the rising edge of MII_P5RXCLK.

Table 3 IO Signals (cont'd)

Ball No.	Name	Pin Type	Buffer Type	Function
52	MII_P5RXDV	I	PD, LVTTTL	Port 5 Receive Data Valid in MII Mode Active high to indicate that the data on MII_P5RXD[3:0] is valid. Synchronous to the rising edge of MII_P5RXCLK.
	RMII_P5CRSDV	I	PD, LVTTTL	Port 5 Carrier Sense and Receive Data Valid in RMII Mode Active high to indicate that the data on RMII_P5RXD[1:0] is valid. Synchronous to the rising edge of REFCLK_IN.
68	MII_P5RXER	I	PD, LVTTTL	Port 5 Receive Error in MII Mode Active high to indicate that there is a symbol error on the MII_P5RXD [3:0]. Only valid in 100M operation.
	RMII_P5RXER	I	PD, LVTTTL	Port 5 Receive Error in RMII Mode Active high to indicate that there is a symbol error on the RMII_P5 RXD[1:0]. Only valid in 100M operation.
57	MII_P5CRS	I	PD, LVTTTL	Port 5 Carrier Sense in MII Mode In full duplex mode, MII_P5CRS reflects the receive carrier sense situation on medium only; In Half Duplex, MII_P5CRS will be high both in receive and transmit condition.
	GPSI_P5CRS	I	PD, LVTTTL	Port 5 Carrier Sense in GPSI Mode In full duplex mode, GPSI_P5CRS reflects the receive carrier sense situation on medium only; In Half Duplex, GPSI_P5CRS will be high both in receive and transmit condition.
58	MII_P5COL	I	PD, LVTTTL	Port 5 Collision Input in MII Mode Active high to indicate that there is a collision on the medium. Stay low in full duplex operation.
	GPSI_P5COL	I	PD, LVTTTL	Port 5 Collision Input in GPSI Mode Active high to indicate that there is collision on the medium. Stay low in full duplex operation.
72	MII_P5RXCLK	I	PD, LVTTTL	Port 5 Receive Clock Input in MII Mode MII_P5RXDV and MII_P5RXD[3:0] are synchronous to the rising edge of this clock. It is free running 25 MHz clock in 100M mode and 2.5 MHz clock in 10M mode.
	GPSI_P5RXCLK	I	PD, LVTTTL	Port 5 Receive Clock Input in GPSI Mode GPSI_P5RXD are synchronous to the rising edge of this clock. It is non-continuous 10 MHz Clock input.
	REFCLK_IN	I	PD, LVTTTL	50MHz Reference Clock Input in RMII Mode RMII_P5RXD[1:0], RMII_P5TXD[1:0], RMII_P5TXEN and RMII_P5CRSDV are synchronous to the rising edge of this clock.

Table 3 IO Signals (cont'd)

Ball No.	Name	Pin Type	Buffer Type	Function
67	MII_P5TXCLK	I	PD, LVTTTL	Port 5 Transmit Clock Input in MII Mode MII_P5TXEN and MII_P5TXD[3:0] are output at the rising edge of this clock. It is free running 25 MHz clock in 100M mode and 2.5 MHz clock in 10M mode.
	GPSI_P5 TXCLK	I	PD, LVTTTL	Port 5 Transmit Clock Input in GPSI Mode GPSI_P5TXEN and GPSI_P5TXD are synchronous to the rising edge of this clock. It is continuous 10 MHz Clock input.
	REFCLK_OUT	O	8 mA, PD, LVTTTL	50MHz Reference Clock Output in RMII Mode This pin is used as 50 MHz reference clock signal output pin when port 5 operates in RMII mode.
89	SPDTNP5	I	PD, LVTTTL	Port 5 Speed Input 0 _B 100M 1 _B 10M
90	LNKFP5	I	PD, LVTTTL	Port 5 Link Fail Status Input 0 _B Link Up 1 _B Link Failed
91	DPHALFP5	I	PD, LVTTTL	Port 5 Duplex Status Input 0 _B Full Duplex 1 _B Half Duplex

LED Interface

107	DPHALFP4	I	PD, LVTTTL	Port 4 Duplex status Input When Port 4 operates under MAC MII mode (see CFG0 for more detail), this pins is used to select the duplex mode of Port 4. 0 _B Full Duplex 1 _B Half Duplex
	DUPCOL4	O	8 mA, PD, LVTTTL	Port 4 Duplex /Collision LED When Port 4 operates under PHY or PCS MII mode (see CFG0 for more details), in Full duplex mode, this pin acts as DUPLEX LED for Port 4, respectively in half duplex mode, it is collision LED for each port. See Chapter 3.23 LED Display for more details.
110	DUPCOL3	O	8 mA, PD, LVTTTL	Port 3 Duplex /Collision LED In Full duplex mode, this pin acts as DUPLEX LED for Port 3, respectively in half duplex mode, it is collision LED for each port. See Chapter 3.23 LED Display for more details.

Table 3 IO Signals (cont'd)

Ball No.	Name	Pin Type	Buffer Type	Function
111	BPEN	I	PU, LVTTL	<p>Recommend Back-Pressure in Half-Duplex Value on this pin will be latched by ADM6996FC/FCX/FHX during power on reset as the back-pressure enable in half-duplex mode.</p> <p><i>Note: Power On Setting</i></p> <p>0_B Disable Back-Pressure 1_B Enable Back-Pressure</p>
	DUPCOL2	O	8 mA, PU, LVTTL	<p>Port 2 Duplex-collision LED In Full duplex mode, this pin acts as Port 2 DUPLEX LED; in half duplex mode, it is collision LED for Port 2. See Chapter 3.23 LED Display for more detail.</p>
112	PHYAS1	I	PD, LVTTL	<p>Recommend PHY Address Bit 1 Value on this pin will be latched by ADM6996FC/FCX/FHX during power on reset as the PHY address recommend value bit 1. See PHYAS0 description for more details.</p> <p><i>Note: Power On Setting</i></p>
	DUPCOL1	O	8 mA, PD, LVTTL	<p>Port 1 Duplex-collision LED In Full duplex mode, this pin acts as port 1 DUPLEX LED; in half duplex mode, it is collision LED for Port 1. See Chapter 3.23 LED Display for more details.</p>
113	RECANEN	I	PU, LVTTL	<p>Recommend Auto Negotiation Enable Only valid for Twisted pair interface. Programmed this bit to 1 has no effect to Fiber port.</p> <p><i>Note: Power On Setting.</i></p> <p>0_B Disable all TP port auto negotiation capability 1_B Enable all TP port auto negotiation capability</p>
	DUPCOL0	O	8 mA, PU, LVTTL	<p>Port 0 Duplex-collision LED In Full duplex mode, this pin acts as port 0 DUPLEX LED; in half duplex mode, it is collision LED for Port 0. See Chapter 3.23 LED Display for more detail.</p>
92	LNKFP4	I	PD, LVTTL	<p>Port 4 Link Fail Status Input When Port 4 operates under MAC MII mode (see CFG0 for more details), this pins is used as link control of Port 4.</p> <p>0_B Link Up 1_B Link Failed</p>
	LNKACT_4	O	8 mA, PD, LVTTL	<p>LINK/Activity LED of Port 4 When Port 4 operates under PHY or PCS MII mode (see CFG0 for more details), this pin is used to indicate the link/activity status of Port 4, see Chapter 3.23 LED Display for more details.</p>
95	LNKACT_3	O	8 mA, PD, LVTTL	<p>LINK/Activity LED of Port 3 to 0 Used to indicate corresponding port' s link/activity status, see Chapter 3.23 LED Display for more details.</p>
96	LNKACT_2			
97	LNKACT_1			
98	LNKACT_0			

Table 3 IO Signals (cont'd)

Ball No.	Name	Pin Type	Buffer Type	Function
51	SPDTNP4	I	PD, LVTTTL	Port 4 Speed Input When Port 4 operates under MAC MII mode (see CFG0 for more details), this pin is used to select the operating speed of Port 4. 0 _B 100M 1 _B 10M
	LDSPD_4	O	8 mA, PD, LVTTTL	Port 4 Speed LED When Port 4 operates under PHY or PCS MII mode (see CFG0 for more details), this pin is used to indicate the speed status of Port 4, see Chapter 3.23 LED Display for more details.
48	LDSPD_3	O	8 mA, PD, LVTTTL	Port 3 to Port 0 Speed LED Used to indicate corresponding port's speed status, see Chapter 3.23 LED Display for more details.
47	LDSPD_2			
43	LDSPD_1			
42	LDSPD_0			

EEPROM Interface

84	EDO	I	PU, LVTTTL	EEPROM Data Output This pin is used to input EEPROM data when reading EEPROM. During ADM6996FC/FCX/FHX initialization, ADM6996FC/FCX/FHX will drive EEPROM interface signal to read settings from EEPROM. Any other devices attached to EEPROM interface SHOULD drive Hi-Z or keep tristate during this period. See Chapter 4.6 EEPROM Access for more details.
80	IFSEL	I	PD, LVTTTL	Interface Selection After the ADM6996FC/FCX/FHX initialization process is done, this pin is used to select using EEPROM interface or SDC/SDIO interface. EECS/IFSEL interface 0 _B SDC/SDIO interface 1 _B EEPROM interface
	EECS	O	4 mA, PD, LVTTTL	EEPROM Chip Select During the ADM6996FC/FCX/FHX initialization this pin is used as EEPROM chip select signal. During the ADM6996FC/FCX/FHX initialize itself, ADM6996FC/FCX/FHX will drive EEPROM interface signal to read settings from EEPROM. Any other devices attached to EEPROM interface SHOULD drive Hi-Z or keep tristate during this period. See Chapter 4.6 EEPROM Access for more details.

Table 3 IO Signals (cont'd)

Ball No.	Name	Pin Type	Buffer Type	Function
81	XOVEN	I	PD, LVTTTL	Cross Over Enable Value on this pin (active low) will be latched by ADM6996FC/FCX/FHX at the rising edge of RESETL(RC) for Port 4~0 crossover auto detect (Only available in TP interface). <i>Note: Power On Setting.</i> 0_B Disable 1_B Enable
	EESK	I/O	4 mA, PD, LVTTTL	EEPROM Serial Clock During the ADM6996FC/FCX/FHX initialize itself, this pin is used to output clock to EEPROM. After ADM6996FC/FCX/FHX initialization process is done, this pin is used as EEPROM interface clock input if IFSEL = 1.
	SDC	I	PD, LVTTTL	Serial Management interface Clock input If IFSEL = 0, this pin is used as serial management interface clock input.
79	LED_MODE	I	PD, LVTTTL	Enable Mac to Choose LED Display Mode Value on this pin will be latched by ADM6996FC/FCX/FHX at the rising edge of RESETL(RC) as single/dual color LED mode control signal. See Chapter 3.23 LED Display for more details. <i>Note: Power On Setting.</i>
	EDI	I/O	8 mA, PD, LVTTTL	EEPROM Serial Data Input During the ADM6996FC/FCX/FHX initialize itself, this pin is used to output address and command to access EEPROM. After the initialization process is done, this pin becomes an input pin to monitor EEPROM data if IFSEL = 1.
	SDIO	I/O	8 mA, PD, LVTTTL	Serial Management interface Data input/Output If IFSEL = 0, this pin is used as data input/output pin of serial management interface.

Power/Ground, 48 Pins

4, 5, 12, 13, 20, 27, 28, 34, 35	GNDA	GND	–	Ground Used by AD Block
1, 9, 17, 24, 38	VCCA2	PWR	–	1.8 V, Power Used by TX Line Driver
8, 16, 23, 31	VCCAD	PWR	–	3.3 V, Power Used by AD Block
126	GNDBIAS	GND	–	Ground Used by Bias Block
128	VCCBIAS	PWR	–	3.3 V, Power Used by Bias Block.
123	GNDPLL	GND	–	Ground Used by PLL

Table 3 IO Signals (cont'd)

Ball No.	Name	Pin Type	Buffer Type	Function
122	VCCPLL	PWR	–	1.8 V, Power Used by PLL
45, 64, 76, 83, 93, 118	GNDIK	GND	–	Ground Used by Digital Core
46, 65, 75, 82, 94, 116	VCCIK	PWR	–	1.8 V, Power Used by Digital Core
50, 69, 70, 87, 99, 108	GNDO	GND	–	Ground Used by Digital Pad
49, 71, 88, 109	VCC3O	PWR	–	3.3 V, Power Used by Digital Pad
Miscellaneous				
41	TEST	I	PD, LVTTTL	Test Mode Reserved and should keep 0 when normal operation.
86	CFG0	I	PU, LVTTTL	Configuration 0 Combined with P4_BUSMD0 and P4_BUSMD1 , ADM6996FC/FCX/FHX provides 3 bus type for port 4. {CFG0, P4_BUSMD[1:0]}, Bus Mode of Port 4 0_00 _B PHY Interface 0_01 _B MAC MII 1_XX _B PCS MII
40	MDIO	I/O	8 mA, PD, LVTTTL	Management Data MDIO transfers management data in and out of the device synchronous to MDC.
44	MDC	I	PD, ST	Management Data Reference Clock A non-continuous clock input for management usage. ADM6996FC/FCX/FHX will use this clock to sample data input on MDIO and drive data onto MDIO according to rising edge of this clock.
85	CKO25M	O	8 mA, PD, LVTTTL	25M Clock Output Free Running 25M Clock output (Even during power on reset)
119	RC	I	ST	RC Input For Power On Reset This pin is sampled by using the 25 MHz free running clock signal which input from XI to generate the low-active reset signal, RESETL. See Chapter 6.3.2 Power On Reset for the timing requirement.
120	XI	AI	ANA	25MHz Crystal /Oscillator Input 25MHz Crystal or Oscillator Input. Variation is limited to +/- 50ppm.
121	XO	AO	ANA	25MHz Crystal Output When connected to oscillator, this pin should left unconnected.
127	RTX	AI	ANA	Constant Voltage Reference External 1.0 kΩ 1% resistor connection to ground.

Table 3 IO Signals (cont'd)

Ball No.	Name	Pin Type	Buffer Type	Function
125	VREF	AI	ANA	Analog Reference Voltage Used by Internal Bias Circuit for voltage reference. External 0.1uF capacitor connection to ground for noise filter.
124	CONTROL	AI/O	ANA	FET Control Signal The pin is used to control FET for 3.3 V to 1.8 V regulator. External 0.1uF capacitor connection to ground for noise filter, even the pin is un-connected.

3 Function Description

3.1 Functional Descriptions

The ADM6996FC/FCX/FHX integrates five 100Base-X physical sub-layer (PHY), 100Base-TX physical medium dependent (PMD) transceivers, five complete 10Base-T modules, a 6 port 10/100 switch controller and one 10/100 MII/GPSI MAC and memory into a single chip for both 10Mbit/s, 100Mbit/s Ethernet switch operation. It also supports 100Base-FX operation through external fiber-optic transceivers. The device is capable of operating in either Full Duplex mode or Half-Duplex mode in 10Mbit/s and 100Mbit/s. Operational modes can be selected by hardware configuration pins, software settings of management registers, or determined by the on-chip auto negotiation logic.

The ADM6996FC/FCX/FHX consists of three major blocks:

- 10/100M PHY Block
- Switch Controller Block
- Built-in SSRAM

The interfaces used for communication between the PHY block and switch core is an MII interface.

An auto MDIX function is supported in this block. This function can be Enabled and Disabled by the hardware pin.

3.2 10/100M PHY Block

The 100Base-X section of the device implements the following functional blocks:

- 100Base-X physical coding sub-layer (PCS)
- 100Base-X physical medium attachment (PMA)
- Twisted-pair transceiver (PMD)

The 100Base-X and 10Base-T sections share the following functional blocks:

- Clock synthesizer module
- MII Registers
- IEEE 802.3u auto negotiation

3.3 100Base-X Module

The ADM6996FC/FCX/FHX implements a 100Base-X compliant PCS and PMA and 100Base-TX compliant TP-PMD as illustrated in Figure 2. Bypass options for each of the major functional blocks within the 100Base-X PCS provides flexibility for various applications. 100Mbit/s PHY loop back is included for diagnostic purpose.

3.4 100Base-X Receiver

The 100Base-X receiver consists of functional blocks required to recover and condition the 125Mbit/s receive data stream. The ADM6996FC/FCX/FHX implements the 100Base-X receiving state machine diagram as given in the ANSI/IEEE Standard 802.3u, Clause 24. The 125Mbit/s receive data stream may originate from the on-chip twisted-pair transceiver in a 100Base-TX application. Alternatively, the receive data stream may be generated by an external optical receiver as in a 100Base-FX application.

The receiver block consists of the following functional sub-blocks:

- A/D Converter
- Adaptive Equalizer and timing recovery module
- NRZI/NRZ and serial/parallel decoder
- De-scrambler
- Symbol alignment block
- Symbol Decoder

- Collision Detect Block
- Carrier sense Block
- Stream decoder block

3.4.1 A/D Converter

A high performance A/D converter with a 125 MHz sampling rate converts signals received on the RXP/RXN pins to 6 bits data streams. It possess an auto-gain-control capability that will further improve receive performance especially under long cabling or harsh detrimental signal integrity. Due to high pass characteristic on a transformer, a built in base-line-wander correcting circuit will be cancelled out and its DC level restored.

3.4.2 Adaptive Equalizer and timing Recovery Module

All digital design is especially immune to noise environments and achieves better correlation between production and system testing. Baud rate Adaptive Equalizer/Timing Recovery compensates for line loss induced from twisted pairs and tracks a far end clock at 125M samples per second. Adaptive Equalizer's implemented with Feed forward and Decision Feedback techniques meet the requirement of BER with less than 10⁻¹² for transmission on a CAT5 twisted pair cable ranging from 0 to 120 meters.

3.4.3 NRZI/NRZ and Serial/Parallel Decoder

The recovered data is converted from NRZI to NRZ. The data is not necessarily aligned to the 4B/5B code group's boundary.

3.4.4 Data De-scrambling

The de-scrambler acquires synchronization with the data stream by recognizing idle bursts of 40 or more bits and locking its deciphering Linear Feedback Shift Register (LFSR) to the state of the scrambling LFSR. Upon achieving synchronization, the incoming data is XORed by the deciphering LFSR and de-scrambled.

In order to maintain synchronization, the de-scrambler continuously monitors the validity of the unscrambled data that it generates. To ensure this, a link state monitor and a hold timer are used to constantly monitor the synchronization status. Upon synchronization of the de-scrambler the hold timer starts a 722 micro second countdown. Upon detection of sufficient idle symbols within the 722 micro sec. period, the hold timer will reset and begin a new countdown. This monitoring operation will continue indefinitely given an operating network connection operating with good signal integrity. If the link state monitor does not recognize sufficient unscrambled idle symbols within the 722 micro second period, the de-scrambler will be forced out of the current state of synchronization and reset in order to re-acquire synchronization.

3.4.5 Symbol Alignment

The symbol alignment circuit in the ADM6996FC/FCX/FHX determines code word alignment by recognizing the /J/K delimiter pair. This circuit operates on unaligned data from the de-scrambler. Once the /J/K symbol pair (11000 10001_B) is detected, subsequent data is aligned on a fixed boundary.

3.4.6 Symbol Decoding

The symbol decoder functions is a look-up table that translates incoming 5B symbols into 4B nibbles as shown in Table 1. The symbol decoder first detects the /J/K symbol pair preceded by idle symbols and replaces the symbol with a MAC preamble. All subsequent 5B symbols are converted to the corresponding 4B nibbles for the duration of the entire packet. This conversion ceases upon the detection of the /T/R symbol pair denoting the end of stream delimiter (ESD). The translated data is presented on the internal RXD[3:0] signal lines where RXD[0] represents the least significant bit of the translated nibble.

3.4.7 Valid Data Signal

The valid data signal (RXDV) indicates that recovered and decoded nibbles are being presented on the internal RXD[3:0] synchronous receive clock, RXCLK. RXDV is asserted when the first nibble of a translated /J/K is ready for transfer over the internal MII. It remains active until either the /T/R delimiter is recognized, link test indicates failure, or no signal is detected. On any of these conditions, RXDV is de-asserted.

3.4.8 Receive Errors

The RXER signal is used to communicate receiver error conditions. While the receiver is in a state of holding RXDV asserted, the RXER will be asserted for each code word that does not map to a valid code-group.

3.4.9 100Base-X Link Monitor

The 100Base-X link monitor function allows the receiver to ensure that reliable data is being received. Without reliable data reception, the link monitor will halt both transmit and receive operations until such time that a valid link is detected.

The ADM6996FC/FCX/FHX performs the link integrity test as outlined in IEEE 100Base-X (Clause 24) link monitor state diagram. The link status is multiplexed with 10Mbit/s link status to form the reportable link status bit in the serial management register 1h, and driven to the LNKACT pin.

When persistent signal energy is detected on the network, the logic moves into a Link-Ready state after approximately 500 micro secs, and waits for an enable from the auto negotiation module. When received, the link-up state is entered, and the transmission and reception logic blocks become active. Should auto negotiation be disabled, the link integrity logic moves immediately to the link-up state after entering the link-ready state.

3.4.10 Carrier Sense

Carrier sense (CRS) for 100 Mbit/s operation is asserted upon the detection of two non contiguous zeros occurring within any 10-bit boundary of the received data stream.

The carrier sense function is independent of symbol alignment. In switch mode, CRS is asserted during either packet transmission or reception. For repeater mode, CRS is asserted only during packet reception. When the idle symbol pair is detected in the received data stream, CRS is de-asserted. In repeater mode, CRS is only asserted due to receive activity. CRS is intended to encapsulate RXDV.

3.4.11 Bad SSD Detection

A Bad Start of Stream Delimiter (Bad SSD) is an error condition that occurs in the 100Base-X receiver if a carrier is detected (CRS asserted) and a valid /J/K set of code-group (SSD) is not received.

If this condition is detected, then the ADM6996FC/FCX/FHX will assert RXER and present RXD[3:0] = 1110_B to the internal MII for the cycles that correspond to received 5B code-groups until at least two idle code-groups are detected. Once at least two idle code groups are detected, RXER and CRS become de-asserted.

3.4.12 Far-End Fault

Auto negotiation provides a mechanism for transferring information from the Local Station to the link Partner that a remote fault has occurred for 100Base-TX. As auto negotiation is not currently specified for operation over fiber, the far end fault indication function (FEFI) provides this capability for 100Base-FX applications.

A remote fault is an error in the link that one station can detect while the other cannot. An example of this is a disconnected wire at a station's transmitter. This station will be receiving valid data and detect that the link is good via the link integrity monitor, but will not be able to detect that its transmission is not propagating to the other station.

A 100Base-FX station that detects such a remote fault may modify its transmitted idle stream from all 1_B's to a group of 84 1_B's followed by a single 0_B. This is referred to as the FEFI idle pattern.

3.5 100Base-TX Transceiver

The ADM6996FC/FCX/FHX implements a TP-PMD compliant transceiver for 100Base-TX operation. The differential transmit driver is shared by the 10Base-T and 100Base-TX subsystems. This arrangement results in one device that uses the same external magnetic for both the 10Base-T and the 100Base-TX transmissions with a simple RC component connection. The individually wave-shaped 10Base-T and 100Base-TX transmit signals are multiplexed in the transmission output driver selection.

3.5.1 Transmit Drivers

The ADM6996FC/FCX/FHX 100Base-TX transmission driver implements MLT-3 translation and wave-shaping functions. The rise/fall time of the output signal is closely controlled to conform to the target range as specified in the ANSI TP-PMD standard.

3.5.2 Twisted-Pair Receiver

For 100Base-TX operation, the incoming signal is detected by the on-chip twisted-pair receiver that consists of a differential line receiver, an adaptive equalizer and a base-line wander compensation circuits.

The ADM6996FC/FCX/FHX uses an adaptive equalizer that changes filter frequency response in accordance with cable length. The cable length is estimated based on the incoming signal strength. The equalizer tunes itself automatically for any cable length to compensate for the amplitude and phase distortions incurred from the cable.

3.6 10Base-T Module

The 10Base-T Transceiver Module is IEEE 802.3 compliant. It includes the receiver, transmitter, collision, heartbeat, loop back, jabber, wave shaper, and link integrity functions, as defined in the standard. Figure 3 provides an overview for the 10Base-T module.

The ADM6996FC/FCX/FHX 10Base-T module is comprised of the following functional blocks:

- Manchester encoder and decoder
- Collision detector
- Link test function
- Transmit driver and receiver
- Serial and parallel interface
- Jabber and SQE test functions
- Polarity detection and correction

3.6.1 Operation Modes

The ADM6996FC/FCX/FHX 10Base-T module is capable of operating in either half-duplex mode or full-duplex mode. In half-duplex mode, the ADM6996FC/FCX/FHX functions as an IEEE 802.3 compliant transceiver with fully integrated filtering. The COL signal is asserted during collisions or jabber events, and the CRS signal is asserted during transmit and receive. In full duplex mode the ADM6996FC/FCX/FHX can simultaneously transmit and receive data.

3.6.2 Manchester Encoder/Decoder

Data encoding and transmission begins when the transmission enable input (TXEN) goes high and continues as long as the transceiver is in a good link state. Transmission ends when the transmission enable input goes low. The last transition occurs at the center of the bit cell if the last bit is a 1_B, or at the boundary of the bit cell if the last bit is 0_B.

Decoding is accomplished using a differential input receiver circuit and a phase-locked loop that separate the Manchester-encoded data stream into clock signals and NRZ data. The decoder detects the end of a frame when

no more mid bit transitions are detected. Within one and a half bit times after the last bit, carrier sense is de-asserted.

3.6.3 Transmit Driver and Receiver

The ADM6996FC/FCX/FHX integrates all the required signal conditioning functions in its 10Base-T block such that external filters are not required. Only one isolation transformer and impedance matching resistors are needed for the 10Base-T transmit and receive interface. The internal transmit filtering ensures that all the harmonics in the transmission signal are attenuated properly.

3.6.4 Smart Squelch

The smart squelch circuit is responsible for determining when valid data is present on the differential receive. The ADM6996FC/FCX/FHX implements an intelligent receive squelch on the RXP/RXN differential inputs to ensure that impulse noise on the receive inputs will not be mistaken for a valid signal. The squelch circuitry employs a combination of amplitude and timing measurements (as specified in the IEEE 802.3 10Base-T standard) to determine the validity of data on the twisted-pair inputs.

The signal at the start of the packet is checked by the analog squelch circuit and any pulses not exceeding the squelch level (either positive or negative, depending upon polarity) will be rejected. Once this first squelch level is overcome correctly, the opposite squelch level must then be exceeded within 150ns. Finally, the signal must exceed the original squelch level within an additional 150ns to ensure that the input waveform will not be rejected.

Only after all these conditions have been satisfied a control signal will be generated to indicate to the remainder of the circuitry that valid data is present.

Valid data is considered to be present until the squelch level has not been generated for a time longer than 200 ns, indicating the end of a packet. Once good data has been detected, the squelch levels are reduced to minimize the effect of noise, causing premature end-of-packet detection. The receive squelch threshold level can be lowered for use in longer cable applications. This is achieved by setting bit 10 of register address 11_H.

3.7 Carrier Sense

Carrier Sense (CRS) is asserted due to receive activity once valid data is detected via the smart squelch function. For 10 Mbit/s half duplex operation, CRS is asserted during either packet transmission or reception. For 10 Mbit/s full duplex and repeater mode operations, the CRS is asserted only due to receive activity.

3.8 Jabber Function

The jabber function monitors the ADM6996FC/FCX/FHX output and disables the transmitter if it attempts to transmit a longer than legal sized packet. If TXEN is high for greater than 24ms, the 10Base-T transmitter will be disabled. Once disabled by the jabber function, the transmitter stays disabled for the entire time that the TXEN signal is asserted. This signal has to be de-asserted for approximately 256 ms (the un-jab time) before the jabber function re-enables the transmit outputs. The jabber function can be disabled by programming bit 4 of register address 10_H to high.

3.9 Link Test Function

A link pulse is used to check the integrity of the connection with the remote end. If valid link pulses are not received, the link detector disables the 10Base-T twisted-pair transmitter, receiver, and collision detection functions.

The link pulse generator produces pulses as defined in IEEE 802.3 10Base-T standard. Each link pulse is nominally 100ns in duration and is transmitted every 16 ms, in the absence of transmit data.

3.10 Automatic Link Polarity Detection

The ADM6996FC/FCX/FHX's 10Base-T transceiver module incorporates an "automatic link polarity detection circuit". The inverted polarity is determined when seven consecutive link pulses of inverted polarity or three consecutive packets are received with inverted end-of-packet pulses. If the input polarity is reversed, the error condition will be automatically corrected and reported in bit 5 of register 10_H.

3.11 Clock Synthesizer

The ADM6996FC/FCX/FHX implements a clock synthesizer that generates all the reference clocks needed from a single external frequency source. The clock source must be a TTL level signal at 25 MHz +/- 50ppm

3.12 Auto Negotiation

The Auto Negotiation function provides a mechanism for exchanging configuration information between two ends of a link segment and automatically selecting the highest performance mode of operation supported by both devices. Fast Link Pulse (FLP) Bursts provide the signaling used to communicate auto negotiation abilities between two devices at each end of a link segment. For further details regarding auto negotiation, refer to Clause 28 of the IEEE 802.3u specification. The ADM6996FC/FCX/FHX supports four different Ethernet protocols, so the inclusion of auto negotiation ensures that the highest performance protocol will be selected based on the ability of the link partner.

Highest priority is relative to the following list:

- 100Base-TX full duplex (highest priority)
- 100Base-TX half duplex
- 10Base-T full duplex
- 10Base-T half duplex (lowest priority)

3.13 Memory Block

The ADM6996FC/FCX/FHX's built in memory is divided into two blocks. One is a MAC addressing table and the other one is a data buffer.

The MAC address Learning Table size has 2K entries with each entry occupying eight bytes length. These eight bytes of data include a 6 byte source address, VLAN information, Port information and an aging counter.

A data buffer is divided into 256 bytes/block. The ADM6996FC/FCX/FHX buffer management is per port fixed block number and all ports share one global buffer. This architecture can get better memory utilization and network balance at different speeds and duplex test conditions.

Received packets will be separated into several 256 bytes/block and chain together. If a packet size is more than 256 bytes then the ADM6996FC/FCX/FHX will chain two or more blocks to store receiving packets.

3.14 Switch Functional Description

The ADM6996FC/FCX/FHX uses a "store & forward" switching approach for the following reason:

- Store & forward switches allow switching between different speed media (e.g. 10BaseX and 100BaseX). Such switches require large elastic buffers especially when bridging between a server on a 100 Mbit/s network and clients on a 10 Mbit/s segment.
- Store & forward switches improve overall network performance by acting as a "network cache"
- Store & forward switches prevent the forwarding of corrupted packets by the frame check sequence (FCS) before forwarding to the destination port.

3.15 Basic Operation

The ADM6996FC/FCX/FHX receives incoming packets from one of its ports, searches in the Address Table for the Destination MAC Address and then forwards the packet to the other port within the same VLAN group, where appropriate. If the destination address is not found in the address table, the ADM6996FC/FCX/FHX treats the packet as a broadcast packet and forwards the packet to the other ports within the same VLAN group.

The ADM6996FC/FCX/FHX automatically learns the port number of attached network devices by examining the Source MAC Address of all incoming packets at wire speed. If the Source Address is not found in the Address Table, the device adds it to the table.

3.15.1 Address Learning

A four-way hash algorithm is implemented to allow the maximum of 4 different addresses with the same hash key to be stored at the same time. Up to 2K entries can be created and all entries are stored in the internal SSRAM. An address is stored in the Address Table. The ADM6996FC/FCX/FHX searches for the Source Address (SA) of an incoming packet in the Address Table and acts as below:

1. If the SA was not found in the Address Table (a new address), the ADM6996FC/FCX/FHX waits until the end of the packet (non-error packet) and updates the Address Table. If the SA was found in the Address Table, then the aging value of each corresponding entry will be reset to 0_B.
2. When the DA is PAUSE command, then the learning process will be disabled automatically by ADM6996FC/FCX/FHX.

3.15.2 Address Recognition and Packet Forwarding

The ADM6996FC/FCX/FHX forwards the incoming packets between bridged ports according to the Destination Address (DA) as below. All the packets forwarded will check the VLAN first. A forwarding port must be within the same VLAN as the source port.

If the DA is a UNICAST address and the address was found in the Address Table, the ADM6996FC/FCX/FHX will check the port number and act as follows:

- If the port number is equal to the port on which the packet was received, the packet is discarded.
- If the port number is different, the packet is forwarded across the bridge.
- If the DA is a UNICAST address and the address was not found, the ADM6996FC/FCX/FHX treats it as a multicast packet and forwards it across the bridge.
- If the DA is a Multicast address, the packet is forwarded across the bridge.
- If the DA is a PAUSE Command (01 80 C2 00 00 01_H), then this packet will be dropped by the ADM6996FC/FCX/FHX. The ADM6996FC/FCX/FHX can issue and learn PAUSE commands.
- The ADM6996FC/FCX/FHX will forward the packet with a DA of (01 80 C2 00 00 00_H), filter out the packet with a DA of (01 80 C2 00 00 01_H), and forward a packet with a DA of (01-80-C2-00-00-02_H to 01 80 C2 00 00 0F_H)

3.15.3 Address Aging

Address aging is supported for topology changes such as an address moving from one port to another. When this happens, the ADM6996FC/FCX/FHX internally has a 300 second timer which will “age-out” (remove) the address from the address table. The aging function can be enabled/disabled by the user. Normally, disabling an aging function is for security purposes.

3.15.4 Back off Algorithm

The ADM6996FC/FCX/FHX implements the truncated exponential back off algorithm compliant to the 802.3 CSMA-CD standard. The ADM6996FC/FCX/FHX will restart the back off algorithm by choosing 0-9 collision counts. The ADM6996FC/FCX/FHX resets the collision counter after 16 consecutive retransmit trials.

3.15.5 Inter-Packet Gap (IPG)

IPG is the idle time between any two successive packets from the same port. The typical number is 96 bits at a time. The value is 9.6 micro secs for 10 Mbit/s Ethernet, 960ns for 100 Mbit/s fast Ethernet. The ADM6996FC/FCX/FHX provides an option of average 92 bit gap in an EEPROM register to shorten the IPG.

3.15.6 Illegal Frames

The ADM6996FC/FCX/FHX will discard all illegal frames such as small packets (less than 64 bytes), oversized packets (greater than 1518 or 1522 bytes) and bad CRC. Dribbling packing with good CRC value will be accepted by the ADM6996FC/FCX/FHX. In case of bypass mode enable, the ADM6996FC/FCX/FHX will support tagged and untagged packets with sizes up to 1522 bytes. In case of non-bypass mode, the ADM6996FC/FCX/FHX will support tagged packets up to 1526bytes and untagged packets up to 1522bytes.

3.15.7 Half Duplex Flow Control

A back pressure function is supported for half-duplex operations. When the ADM6996FC/FCX/FHX cannot allocate a receive buffer for an incoming packet (buffer full), the device will transmit a jam pattern on the port, thus forcing a collision. Back Pressure is enabled by the BPEN set during RESET assertion. An Infineon proprietary algorithm is implemented inside the ADM6996FC/FCX/FHX to prevent the back pressure function causing HUB partitioned under heavy traffic environment and reducing the packet loss rate to increase the whole system performance.

3.15.8 Full Duplex Flow Control

When full duplex port run out of its receive buffer, a PAUSE packet command will be issued by ADM6996FC/FCX/FHX to notice the packet sender to pause transmission. This frame based flow control is totally compliant to IEEE 802.3x. ADM6996FC/FCX/FHX can issue or receive pause packet.

3.15.9 Old Broadcast Storm filter (0x0b[0]=0 and 0x11[6]=0)

If the Broadcast Storm filter is enabled, the broadcast packets over 50 ms of the threshold will be discarded by the threshold setting. See EEPROM Reg.10_H.

Broadcast storm mode:

Time interval: 50ms

Max. packet number = 7490 in 100Base, 749 in 10Base

Table 4 The max. packet number = 7490 in 100Base, 749 in 10Base

Per Port Falling Threshold				
	00 _B	01 _B	10 _B	11 _B
All 100TX	Disable	7440fps	14880fps	29760fps
Not All 100TX	Disable	744fps	1488fps	2976fps

Table 5 The max. packet number = 7490 in 100Base, 749 in 10Base

Per Port Rising Threshold				
	00 _B	01 _B	10 _B	11 _B
All 100TX	Disable	14880fps	29760fps	59520fps
Not All 100TX	Disable	1488fps	2976fps	5952fps

3.15.10 New Broadcast/Multicast Storm (0x0b[0]=1 and 0x11[6]=1)

ADM6996FC/FCX allows users to limit the traffic of the broadcast address (DA = FFFFFFFF_H) to prevent them from blocking the switch bandwidth. If users also want to limit the multicast packets (DA[40] = 1_B), they can set the Multicast Packet Counted into Storming Counter (see 0010_H[5]) function. Two thresholds and storm enable bits (see 003B_H and 003C_H) are used to control the broadcast storm.

1. Time Scale. ADM6996FC/FCX uses 50ms as a scale to meter the storm packets.

Parameter	Rising Threshold	Falling Threshold
All link ports are 100M	100M Threshold (See 003B _H [12:0])	1/2 100M Threshold
All link ports are not all 100M	10M Threshold (See 003C _H [12:0])	1/2 10M Threshold

2. Storm keeps on at least 1.6 seconds if any of the ports meets the rising threshold in the 4 consecutive 50 ms intervals. In these 1.6 seconds, the ports meeting the rising threshold will start to discard the broadcast or multicast packets until the 50 ms interval expires. Users could also disable Input Filter (see 000B_H[14]) function to forward above packets to the un-congested port instead of discarding directly.

3. Storm finishes. After the 1.6-second storm period, ADM6996FC/FCX will check the port that makes the storm on. If all of these ports meet the falling threshold in the 2 consecutive 50 ms intervals and no other ports satisfy the rising threshold at the same time, the storm will finish.

3.16 Auto TP MDIX Function

A normal application which Switch connect to NIC cards is one by one TP cable. If Switch connects an other device such as another Switch it must be by two ways. First one is Cross Over TP cable. Second way is use extra RJ45 which crossover internal TX+- and RX+- signal. By second way customer can use one by one cable to connect two Switch devices. All these efforts cause increased costs and are not good solutions. ADM6996FC/FCX/FHX provides an Auto MDIX function which can adjust TX+- and RX+- at correct pin. User can use one by one cable between ADM6996FC/FCX/FHX and another device. This function can be Enable/Disable by hardware pin and EEPROM configuration register 01_H ~ 09_H bit 15. If hardware pin sets all ports at Auto MDIX mode then EEPROM setting is useless. If hardware pin sets all ports at non Auto MDIX mode then EEPROM can set each port of this function enable or disable.

3.17 Port Locking

The Port Locking function will provide customers with a simple way to limit per port user number to one. If this function is turned on then the ADM6996FC/FCX/FHX will lock the first MAC address in the learning table. After this MAC address locking will never age out except with a Reset signal. Another MAC address which is not the same as the locked one will be dropped. ADM6996FC/FCX/FHX provides one MAC address per port. This function is per port setting. When the Port Locking function is turned on, it is recommended to turn off the aging function. See EEPROM register 12_H bit 0~8.

3.18 VLAN setting & Tag/Untag & port-base VLAN

ADM6996FC/FCX/FHX supports bypass mode and untagged port as default setting while the chip is power-on. Thus, every packet with or without tag will be forwarding to the destination port without any modification by ADM6996FC/FCX/FHX. Meanwhile port-base VLAN could be enabled according to the PVID value (user define 4bits to map 16 groups written at register 13_H to register 22_H) of the configuration content of each port.

ADM6996FC/FCX/FHX also supports 16 802.1Q VLAN groups. In VLAN four bytes tags include twelve VLAN ID. ADM6996FC/FCX/FHX lets a user define four bits of VID. If the user needs to use this function, two EEPROM registers are needed to be programmed first:

* Port VID number at EEPROM register 01_H ~ 09_H bit 13~10, register 28_H ~ 2B_H and register 2C_H bit 7~0: ADM6996FC/FCX/FHX will check coming packet. If coming packet is non VLAN packet then

ADM6996FC/FCX/FHX will use PVID as VLAN group reference. ADM6996FC/FCX/FHX will use packet's VLAN value when receive tagged packet.

* VLAN Group Mapping Register. EEPROM register 13_H ~ 22_H define VLAN grouping value. User use these register to define VLAN group.

User can define each port as Tag port or Untag port by Configuration register Bit 4. The operation of packet between Tag port and Untag port can be explained by following example:

Example 1: Port receives Untag packet and send to Untag port.

ADM6996FC/FCX/FHX will check the port user defined four bits of VLAN ID first then check VLAN group register. If the destination port is the same VLAN as the receiving port then this packet will forward to destination port without any change. If the destination port is not the same VLAN as the receiving port then this packet will be dropped.

Example 2: Port receives Untag packet and send to Tag port.

ADM6996FC/FCX/FHX will check the port user define fours bits of VLAN ID first then check VLAN group register. If destination port same VLAN as receiving port than this packet will forward to destination port with four byte VLAN Tag and new CRC. If destination port not same VLAN as receiving port then this packet will be dropped.

Example 3: Port receives Tag packet and send to Untag port.

ADM6996FC/FCX/FHX will check the packet VLAN ID first then check VLAN group register. If the destination port is the same VLAN as the receiving port than this packet will forward to destination port after removing four bytes with new CRC error. If the destination port is not the same VLAN as the receiving port then this packet will be dropped.

Example 4: Port receives Tag packet and send to Tag port.

ADM6996FC/FCX/FHX will check the user define packet VLAN ID first then check VLAN group register. If the destination port is the same VLAN as the receiving port than this packet will forward to destination port without any change. If destination port is not the same VLAN as the receiving port then this packet will be dropped.

3.19 Old Fixed Ingress Bandwidth Control (0x0b[0]=0)

ADM6996FC/FCX/FHX also supports ADM6996F compatible Bandwidth Control with fixed rate.

Table 6 Fixed Ingress Bandwidth Control

000	001	010	011	100	101	110	111
256 K	512 K	1 M	2 M	5 M	10 M	20 M	50 M

3.20 New Scalable Egress/Ingress Bandwidth Control (0x0b[0]=1 and 0x33[12]=1)

Bandwidth control function is useful on community networks for different levels of service. ADM6996FC/FCX/FHX provides Scalable Egress/Ingress Bandwidth Control. Users can set any value that is based on a 64K unit.

3.21 MAC Table Accessible

A CPU accesses a Switch's internal MAC table which is provided by ADM6996FC/FCX/FHX. The CPU can Search, Add, Delete and Set Samurai-6FC/FCX's (ADM6996FC/FCX) internal MAC table through a serial interface.

Search: CPU can search target MAC address Switch port number.

Add: CPU can add MAC address to learning table.

Delete: CPU can delete MAC address from learning table.

Set MAC Address: CPU can set MAC address as Static or no Static address. Static means not aging out.

3.22 Priority Setting

It is a trend that data, voice and video will be put on a network. A Switch does not only deal with data packets but also provides service of multimedia data. ADM6996FC/FCX/FHX provides four priority queues on each port with 8:4:2:1 rate. See EEPROM Reg.10_H.

This priority function can set three ways as below:

- * By Port Base: Set specific port at specific queue. ADM6996FC/FCX/FHX only check the port priority and does not check packet's content VLAN and TOS.
- * By VLAN first: ADM6996FC/FCX/FHX checks VLAN's three priority bit first then IP TOS priority bits.
- * By IP TOS first: ADM6996FC/FCX/FHX checks IP TOS's three priority bits first then VLAN's three priority bits. If a port is set at VLAN/TOS priority but the receiving packet is without VLAN or TOS information then port base priority will be used.
- * By TCP/UDP Destination Port Number: ADM6996FC/FCX/FHX check Layer4 TCP/UDP Destination Port number to map the priority queue.
- * By MAC Destination Address: User can set MAC address to map priority queue.

3.23 LED Display

Three LED per port are provided by ADM6996FC/FCX/FHX. Link/Act, Duplex/Col. & Speed are three LED displays of ADM6996FC/FCX/FHX. Dual color LED mode is also supported by ADM6996FC/FCX/FHX. For easy production purpose ADM6996FC/FCX/FHX will send test signal to each LED at power on reset stage. EEPROM register 12_H define LED configuration table.

1. **LED_MODE**: It is the value latched on the EDI pin during the power on reset. It's also used to control the dual or single color mode and is useless when the value wait_init is high.
2. **DUP_COL_SEP** (see 0012_H): Dupcol LEDs indicate the duplex status only.
3. **DHCOL_LED_EN** (See 0030_H): When enabled, pin DUPCOL0 shows col_10m status and pin DUPCOL1 shows col_100m status. These two LEDs are necessary in the dual-speed hub.

ADM6996FC/FCX/FHX LED is active Low signal. Dupcol0 & Dupcol1 will check external signal at Reset time. If external signal adds pull high then LED will active Low. If external signal adds pull down resistor then LED will drive high.

3.23.1 Single Color LED Display

Table 7 Single Color LED Display

Pin Name	Status
LNKACT4/LNKACT3/ LNKACT2/LNKACT1/ LNKACT0	<p>These pins have no power-on reset values on them, and ADM6996FC/FCX/FHX uses active low value to drive the led. So the output values of these pins after the power on reset are shown as follows:</p> <ol style="list-style-type: none"> 1. First period: This period lasts 1.28 s for LED on test. ADM6996FC/FCX/FHX drives value 0 to open the LED. 2. Second period: This period lasts 0.48 s for LED off test. ADM6996FC/FCX/FHX drives value 1 to close the LED. 3. Normal Period: This period indicates the link status. <ul style="list-style-type: none"> 0_B Port links up and LED is ON. 1_B Port links down and LED is OFF. 0/1_B Port links up and is transmitting or receiving. The LED flashes at 10 Hz.
LDSPD4/LDSPD3/ LDSPD2/LDSPD1/ LDSPD0	<p>The behavior of these pins is the same as the LNKACT, except the normal period.</p> <p>Normal period: This period indicates the speed status.</p> <ul style="list-style-type: none"> 0_B Port links up and its speed is 100M. LED is ON. 1_B Port links down or its speed is 10M. LED is OFF.

Table 7 Single Color LED Display (cont'd)

Pin Name	Status
DUPCOL2/ DUPCOL1/ DUPCOL0	<p>These 3 pins have power-on reset values on them. ADM6996FC/FCX/FHX needs to consider these values to drive the correct value. If the power on reset value is <code>value_power_on</code>, then the display is as follows:</p> <ol style="list-style-type: none"> 1. First period: This period lasts 1.28 s for LED on test. ADM6996FC/FCX/FHX drives <code>~value_power_on</code> to open the LED. 2. Second period: This period lasts 0.48 s for LED off test. ADM6996FC/FCX/FHX drives <code>value_power_on</code> to close the LED. 3. Normal Period: This period indicates the duplex/collision status. <ul style="list-style-type: none"> <code>~value_power_on</code> = Port links up in the full-duplex mode. LED is ON. <code>value_power_on</code> = Port links down. LED flashes at 10 Hz. <code>0/1_B</code> Port links up and collision is detected. The LED flashes at 10 Hz. <p>If DUP_COL_SEP is enabled, the normal period changes its way to display.</p> <ul style="list-style-type: none"> <code>~value_power_on</code> = Port links up in the duplex mode. LED is ON. <code>value_power_on</code> = Port links down or links up in the half-duplex mode. LED is OFF. <code>0/1_B</code> This value is cancelled. LED doesn't blink. <p>If DHCOL_LED_EN is enabled, the display in the normal period is as follows:</p> <p>DUPCOL0: 10m collision indicator.</p> <ul style="list-style-type: none"> <code>0/1_B</code> One of the ports links up in 10M half-duplex mode and detects a collision event. The LED flashes at 20 Hz. <code>value_power_on</code> = When the above event is not satisfied, the LED is OFF. <p>DUPCOL1: 100 m collision indicator.</p> <ul style="list-style-type: none"> <code>0/1_B</code> One of the ports links up in 100M half-duplex mode and detects a collision event. The LED flashes at 20 Hz. <code>value_power_on</code> = The above event is not satisfied. LED is OFF.
DUPCOL4/ DUPCOL3	<p>The behavior of these pins is the same as the LNKACT, except the normal period.</p> <p>Normal period: This period indicates the duplex/collision status.</p> <ul style="list-style-type: none"> <code>~value_power_on</code> = Port links up in the full-duplex mode. LED is ON. <code>value_power_on</code> = Port links down. LED is OFF. <code>0/1_B</code> Port links up and collision is detected. The LED flashes at 10 Hz. <p>If DUP_COL_SEP is enabled, the normal period changes its way to display.</p> <ul style="list-style-type: none"> <code>~value_power_on</code> = Port links up in the duplex mode. LED is ON. <code>value_power_on</code> = Port links down or links up in the half-duplex mode. LED is OFF. <code>0/1_B</code> This value is cancelled. LED doesn't blink.

3.23.2 Dual Color LED Display

Users should be careful that DUPCOL LED only supports the single color mode. The only difference between single and dual color for DUPCOL LED is the self-test time.

Table 8 Dual Color LED Display

Pin Name	Status
(LNKACT4, LDSPD4)/ (LNKACT3, LDSPD3) (LNKACT2, LDSPD2) (LNKACT1, LDSPD1) (LNKACT0, LDSPD0)	First Period: Test LED is on with green color. It lasts 1.28 s. 01 _B LED is on with green color. Second Period: Test LED is on with yellow color. It lasts 1.28 s. 10 _B LED is on with yellow color. Third period: Test LED off. 00 _B LED is off. Normal Period: This period shows the status of the link and speed at the same time. 00 _B Port links down. LED is off. 11 _B Port links down. LED is off. 01 _B Port links up in 100M. LED glows green. 10 _B Port links up in 10M. LED glows yellow. 0/1, 1 _B Port links up in 100M and is receiving or transmitting. LED blinks with green color at 10 Hz. 0/1, 0 _B Port links up in 10M and is receiving or transmitting. LED blinks with yellow color at 10 Hz.
DUPCOL4/DUPCOL3/ DUPCOL2/DUPCOL1/ DUPCOL0	The behavior of these pins is the same as the single mode, except the self-test period. The LED on test period is 2.56 s instead of 1.28 s.

3.23.3 Circuit for Single LED Mode

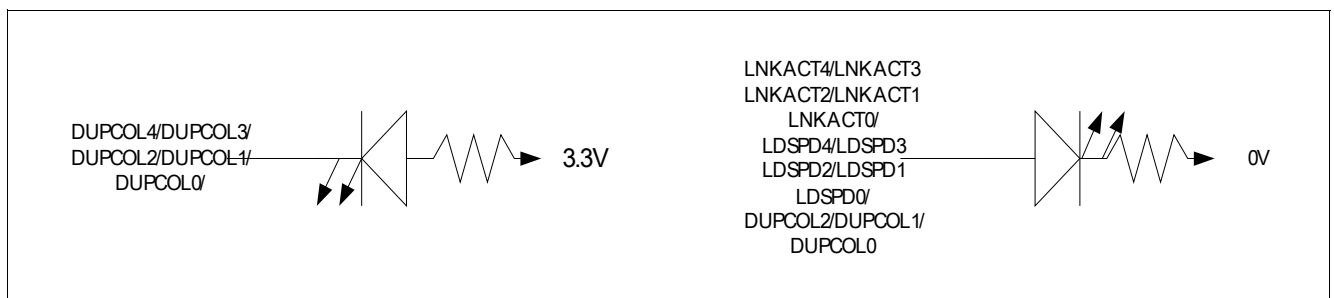

Figure 3 Circuit for Single Color LED Mode

3.23.4 Circuit for Dual Led Mode

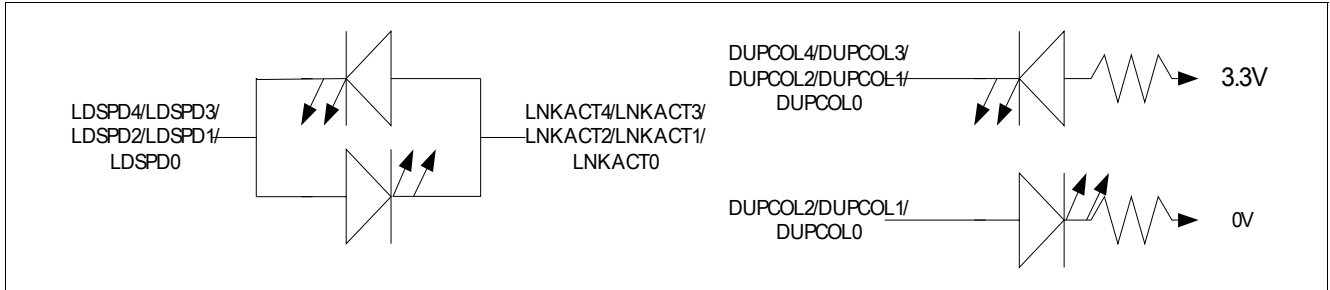

Figure 4 Circuit for Dual Color LED Mode

3.24 Port4 and Port5 MII connection

In ADM6996FC/FCX, there are 3 different configurations (Normal PHY, MAC type MII and PCS type MII, **CFG0**) for Port4. If Port4 is configured in normal PHY mode, then it is identical to Port0~Port3 and Port4's MII signals are ignored. If Port4 is configured in MAC type MII mode, it can be used for the HomePNA application and embedded single PHY will not be used. In ADM6996FC/FCX, the most popular is to configure Port4 as the PCS type MII for the router's WAN port application. Users can see [Figure 5](#) and [Figure 6](#) for more clear picture. For the Port5, there are three different configurations (MAC type MII mode, GPSI mode and RMII, **P5_BUSMD0**) for connecting to CPU's MII/GPSI or RMII interface.

Here we depicted two general router applications of ADM6996FC/FCX, one is connected to CPU with single MII and another is connected to CPU with dual MII. In [Figure 5](#), we can see either LAN to WAN or WAN to LAN, the packets will go through the same MII port. Because the CPU need to send out the packets with the registered MAC ID to the WAN port, and this MAC ID may also come in from the LAN ports. We know the switch learning scheme can't permit the packets with same MAC ID input from different port. In the ADM6996FC/FCX design, we use the MAC clone and VLAN group to solve this problem. From [Figure 7](#), users can have more details for this implementation.

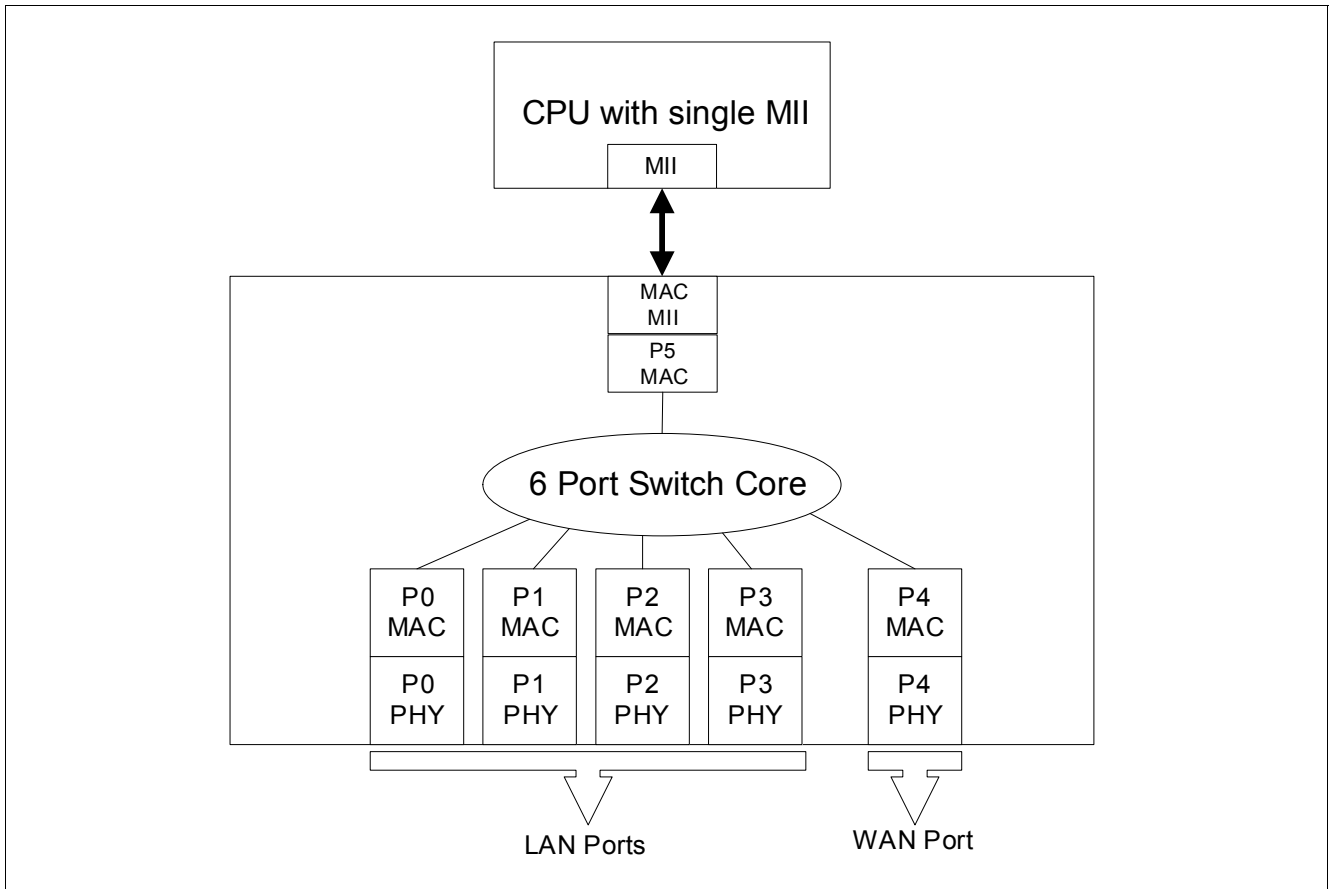

Figure 5 ADM6996FC/FCX to CPU with single MII connection

In **Figure 6**, it shows an easy way to connect the CPU with dual MII for the routing application. In this application, Port4's embedded and isolated PHY will be connected to the WAN port. CPU will act as the bridge to translate the packet's frame for LAN/WAN and use different MII to handle the packets either from LAN to WAN or from WAN to LAN. The isolated PHY is helpful to reduce the BOM cost.

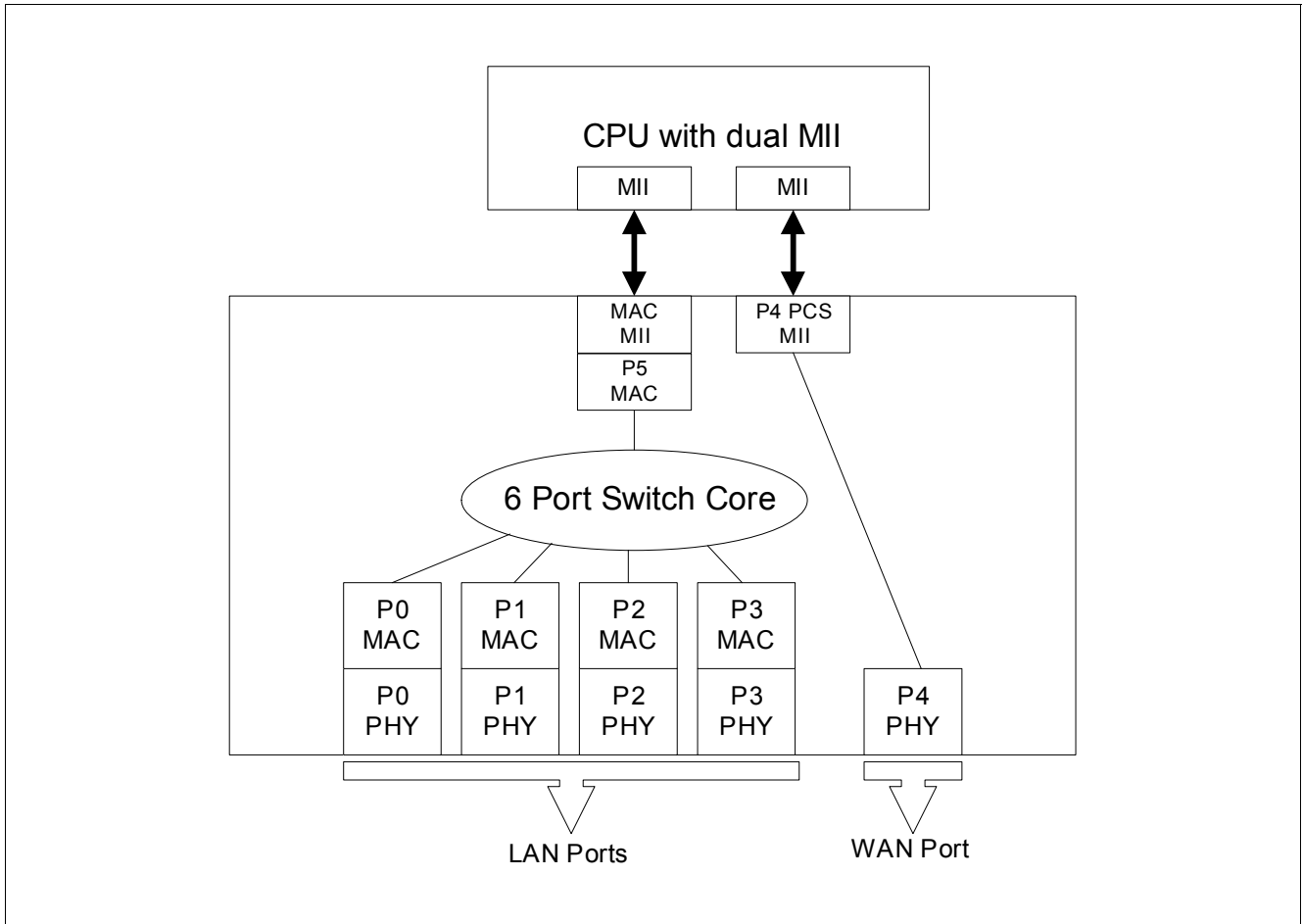

Figure 6 ADM6996FC/FCX to CPU with dual MII connection

Here we use an example to describe how to enable the MAC clone and set the VLAN group to reach this LAN/WAN routing activity.

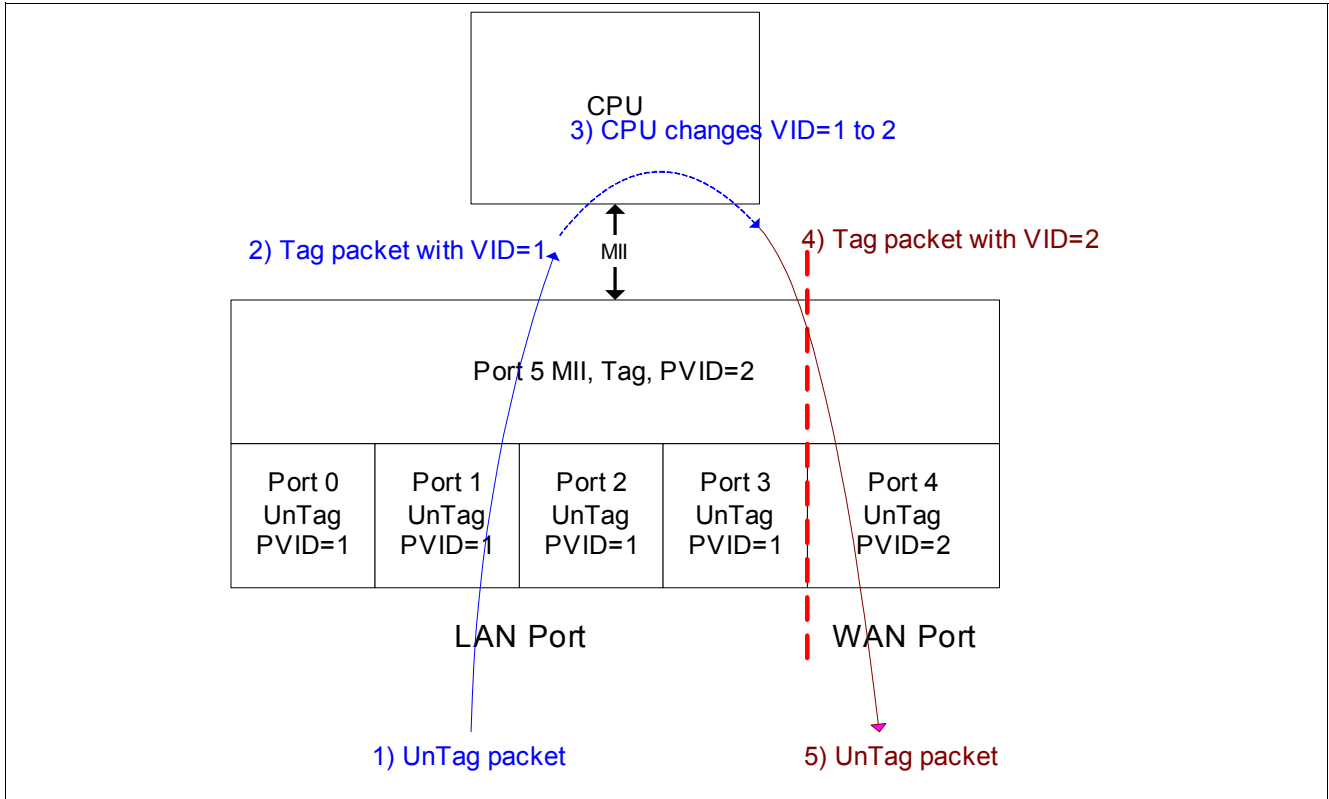

Figure 7 MAC Clone Enable and VLAN Setting

Step1: Set ADM6996FC/FCX to tag-based VLAN mode -- set EEPROM 0x11_H to 0xff20_H

Step2: Set per port PVID and Tag/UnTag output port --

Port0, UnTag, PVID=1, set EEPROM 0x01_H to 0x840f_H

Port1, UnTag, PVID=1, set EEPROM 0x03_H to 0x840f_H

Port2, UnTag, PVID=1, set EEPROM 0x05_H to 0x840f_H

Port3, UnTag, PVID=1, set EEPROM 0x07_H to 0x840f_H

Port4, UnTag, PVID=2, set EEPROM 0x08_H to 0x880f_H

Port5, Tag, PVID=2, set EEPROM 0x09_H to 0x881f_H

Step3: Set WAN/LAN group

Group1: Port 0/1/2/3/5, set EEPROM 0x14_H to 0x0155_H

Group2: Port 4/5, set EEPROM 0x15_H to 0x0180_H

If Untag packet received from LAN port and forwards to CPU port, ADM6996FC/FCX will use ingress port PVID as the egress tag VID. CPU can recognize the source group of the packet by VID. If VID=1, it means the packet is received from the LAN port. Otherwise, if VID=2, it means the packet is received from the WAN port.

CPU has to change the tag VID to determine the destination group. The tag packet received from CPU port will follow tag-based VLAN to determine the broadcast domain. If the tag packet with VID=1 will follow VLAN group 1 (LAN group) and the tag packet with VID=2 will follow the VLAN group 2 (WAN group).

Normally, the MAC mode MII should be connected to the PCS mode MII. But in some applications, we need to connect both MAC mode MII to each other as shown in above figures. In **Figure 6**, due to most of CPU's MII are MAC mode, so Port4 is PCS to MAC connection and Port5 is MAC to MAC connection.

Through the hardware setting, it is easy to set ADM6996FC/FCX Port5 MII be operating in 100M Full duplex mode. And this kind mode (100M Full) is normally the operation mode to be with CPU, the interface connection is described in the following diagram.

(1) CKO25M is the 25M clock driven out by ADM6996FC/FCX to fit 100M MII operation. This clock output provides 8mA driving capability and it can directly connected to TXCLK/RXCLK.

(2) Due to it is operated in Full duplex mode, so COL is tied to GND.

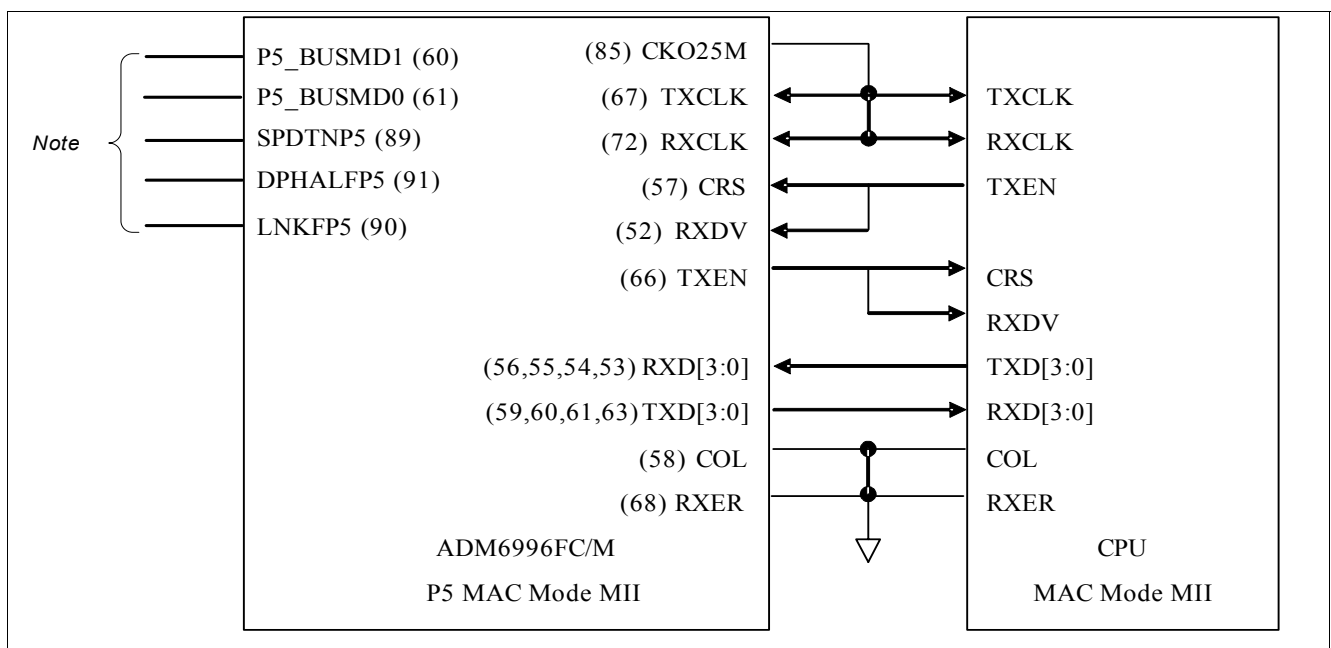

Figure 8 100M Full duplex MAC to MAC MII connection

Note:

1. Pin 60 and pin 61 should be pull low to let P5_BUSMD be latched as "00" and make Port5 be operating in MII mode (**P5_BUSMD0**).
2. Pin 89 (SPDTNP5) should be pull low or floating to set Port5 be operating in 100Mbit/s.
3. Pin 91 (DPHALFP5) should be pull low or floating to set Port5 be operating in full duplex mode.
4. Pin 90 (LNKFP5) should be pull low or floating to set Port5 Link up.

About the PCS mode MII connect to MAC mode MII, it's very straightforward. If PCS and MAC follow the MII standard timing and users notice the PCB layout balance, it should not be an issue for PCS to connect the MAC. In **Figure 9**, we depicted this interface connection and described how to configure Port4 as the PCS mode MII.

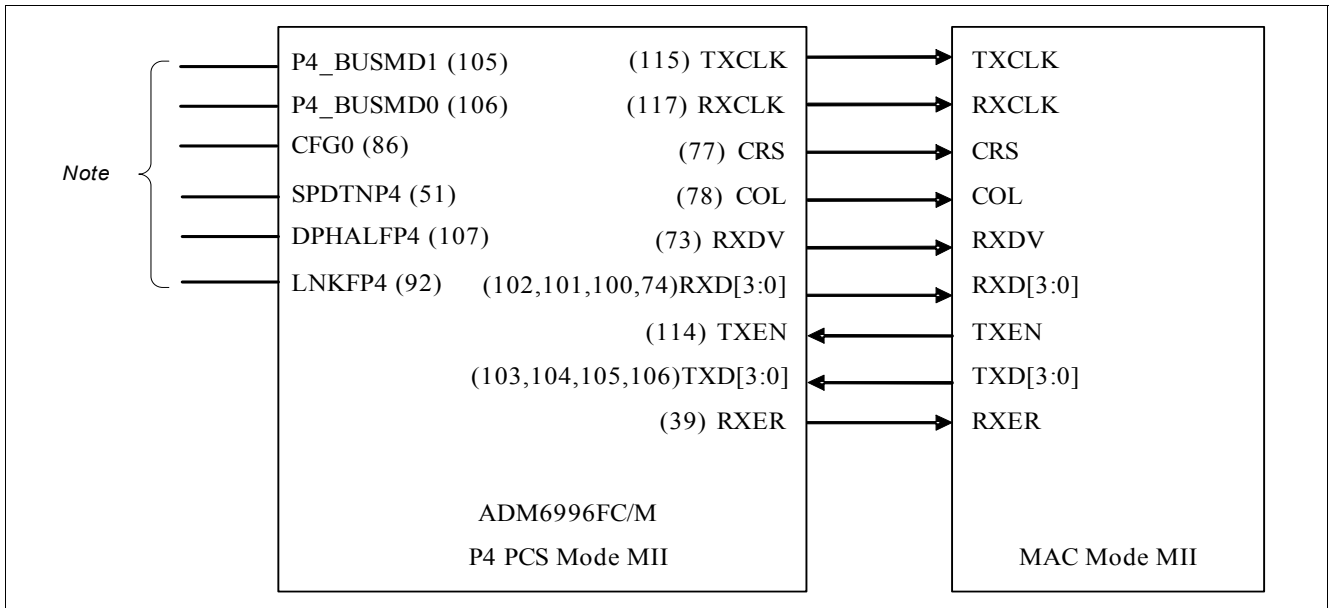

Figure 9 PCS to MAC MII connection

Note:

5. From **CFG0** pin description, we know it needs to set {CFG0, P4_BUSMD[1:0]} as $1x_B$ to configure Port4 be operating in PCS mode MII. So it doesn't matter the value on P4_BUSMD[1:0] (pin 105 and pin 106) and we only pull high the CFG0 or make it floating (due to it has internally pull high) is ok.
6. Pin 51 (SPDTNP4) acts as DUPLEX LED for Port 4; in half duplex mode, it is collision LED for each port.
7. Pin 107 (DPHALFP4) used to indicate the speed status of Port 4.
8. Pin 92 (LNKFP4) used to indicate the link/activity status of Port 4.

3.25 The Hardware Difference between ADM6996FC/FCX and ADM6996F

ADM6996FC/FCX is power-down version to replace ADM6996F and ADM6996M is advanced function version to new application.

Pin Description(QFP128)

Table 9 Pin Description(QFP128)

Pin No.	ADM6996FC/FCX	ADM6996F	Notes
59	P5TXD3(SDIO_MD)	P5TXD3(VOL23)	For ADM6996FC/FCX, SDIO_MD=0 default 32bit mode For ADM6996M, SDIO_MD=0 default 16bit mode Add pull-up/down resistor for ADM6996F/FC/M compatible design to avoid wrong power-on-latch.
60	P5TXD2(RMIISEL)	P5TXD2(ROMCODE25)	Add pull down resistor for ADM6996F/FC/M P5 MII mode to avoid wrong power-on-latch.
61	P5TXD1(7WIRE)	P5TXD1(P5GPSI)	Add pull down resistor for ADM6996F/FC/M P5 MII mode to avoid wrong power-on-latch.
65	INT_N	VCCIK(1.8V Digital)	Interrupt for Learning Table Access/Port Security/Counter Overflow/Port Status Add a option design to CPU INT_N pin

4 Registers Description

4.1 EEPROM Register (0x0b[0]=0)

Table 10 Registers Address Space

Module	Base Address	End Address	Note
EEPROM	00 _H	33 _H	Independent Address Space

Table 11 Registers Overview

Register Short Name	Register Long Name	Offset Address	Page Number
SigReg	Signature Register	00 _H	50
CtrlReg_0	Basic Control Register 0	01 _H	51
ResReg_0	Reserved Register 0	02 _H	52
CtrlReg_P1	Basic Control Register 1	03 _H	52
ResReg_1	Reserved Register 1	04 _H	52
CtrlReg_P2	Basic Control Register 2	05 _H	52
ResReg_2	Reserved Register 2	06 _H	52
CtrlReg_P3	Basic Control Register 3	07 _H	52
CtrlReg_P4	Basic Control Register 4	08 _H	52
CtrlReg_P5	Basic Control Register 5	09 _H	52
ResReg_4	Reserved Register 4	0A _H	53
ConfigReg_1	Configuration Register 1	0B _H	53
ResReg_5	Reserved Register 5	0C _H	53
ResReg_6	Reserved Register 6	0D _H	54
VLAN_Map_P	VLAN priority Map Register	0E _H	54
TOS_Priority	TOS priority Map Register	0F _H	55
ConfigReg_2	Configuration Register 2	10 _H	55
VLAN_Mode	VLAN Mode Select Register	11 _H	56
ConfigReg_3	Miscellaneous Configuration Register 3	12 _H	59
VLAN_Map_0	VLAN mapping table registers 0	13 _H	60
VLAN_Map_1	VLAN mapping table registers 1	14 _H	61
VLAN_Map_2	VLAN mapping table registers 2	15 _H	61
VLAN_Map_3	VLAN mapping table registers 3	16 _H	61
VLAN_Map_4	VLAN mapping table registers 4	17 _H	61
VLAN_Map_5	VLAN mapping table registers 5	18 _H	61
VLAN_Map_6	VLAN mapping table registers 6	19 _H	61
VLAN_Map_7	VLAN mapping table registers 7	1A _H	61
VLAN_Map_8	VLAN mapping table registers 8	1B _H	61
VLAN_Map_9	VLAN mapping table registers 9	1C _H	61
VLAN_Map_10	VLAN mapping table registers 10	1D _H	61

Table 11 Registers Overview (cont'd)

Register Short Name	Register Long Name	Offset Address	Page Number
VLAN_Map_11	VLAN mapping table registers 11	1E _H	61
VLAN_Map_12	VLAN mapping table registers 12	1F _H	61
VLAN_Map_13	VLAN mapping table registers 13	20 _H	61
VLAN_Map_14	VLAN mapping table registers 14	21 _H	61
VLAN_Map_15	VLAN mapping table registers 15	22 _H	61
ResReg_7	Reserved Register 7	23 _H	61
ResReg_8	Reserved Register 8	24 _H	62
ResReg_9	Reserved Register 9	25 _H	62
ResReg_10	Reserved Register 10	26 _H	62
ResReg_11	Reserved Register 11	27 _H	62
ConfigReg_4	Configuration Register 4	28 _H	62
ConfigReg_5	Configuration Register 5	29 _H	62
ConfigReg_6	Configuration Register 6	2A _H	63
ConfigReg_7	Configuration Register 7	2B _H	63
ConfigReg_8	Configuration Register	2C _H	64
ResReg_12	Reserved Register 12	2D _H	65
ResReg_13	Reserved Register 13	2E _H	65
PH_Restart	PHY Restart	2F _H	65
ConfigReg_9	Miscellaneous Configuration Register 9	30 _H	66
BWCon_0	Bandwidth Control Register 0	31 _H	66
BWCon_1	Bandwidth Control Register 1	32 _H	67
BWConEn	Bandwidth Control Enable Register	33 _H	68

The register is addressed wordwise.

Table 12 Register Access Types

Mode	Symbol	Description HW	Description SW
read/write	rw	Register is used as input for the HW	Register is read and writable by SW
read	r	Register is written by HW (register between input and output -> one cycle delay)	Value written by software is ignored by hardware; that is, software may write any value to this field without affecting hardware behavior (= Target for development.)
Read only	ro	Register is set by HW (register between input and output -> one cycle delay)	SW can only read this register
Read virtual	rv	Physically, there is no new register, the input of the signal is connected directly to the address multiplexer.	SW can only read this register
Latch high, self clearing	lhsc	Latch high signal at high level, clear on read	SW can read the register
Latch low, self clearing	llsc	Latch high signal at low-level, clear on read	SW can read the register
Latch high, mask clearing	lhmk	Latch high signal at high level, register cleared with written mask	SW can read the register, with write mask the register can be cleared (1 clears)

Table 12 Register Access Types (cont'd)

Mode	Symbol	Description HW	Description SW
Latch low, mask clearing	llmk	Latch high signal at low-level, register cleared on read	SW can read the register, with write mask the register can be cleared (1 clears)
Interrupt high, self clearing	ihsc	Differentiate the input signal (low->high) register cleared on read	SW can read the register
Interrupt low, self clearing	ilsc	Differentiate the input signal (high->low) register cleared on read	SW can read the register
Interrupt high, mask clearing	ihmk	Differentiate the input signal (high->low) register cleared with written mask	SW can read the register, with write mask the register can be cleared
Interrupt low, mask clearing	ilmk	Differentiate the input signal (low->high) register cleared with written mask	SW can read the register, with write mask the register can be cleared
Interrupt enable register	ien	Enables the interrupt source for interrupt generation	SW can read and write this register
latch_on_reset	lor	rw register, value is latched after first clock cycle after reset	Register is read and writable by SW
Read/write self clearing	rwsc	Register is used as input for the hw, the register will be cleared due to a HW mechanism.	Writing to the register generates a strobe signal for the HW (1 pdi clock cycle) Register is read and writable by SW.

Table 13 Registers Clock Domains

Clock Short Name	Description
–	–

4.1.1 EEPROM Contents

Signature Register

Description

SigReg	Offset	Reset Value
Signature Register	00_H	4154_H

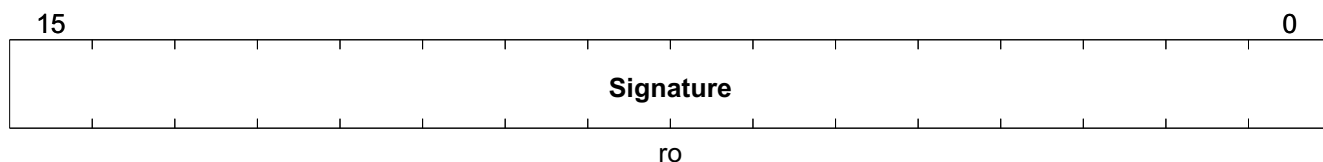

Field	Bits	Type	Description
Signature	15:0	ro	Signature 4154 _H SigReg Obligatory value (AT)

Note: ADM6996FC/FCX/FHX will check register 0 value before read all EEPROM content. If this value does not match with 0x4154h then other values in EEPROM will be useless. ADM6996FC/FCX/FHX will use internal default value. User cannot write Signature register when programming ADM6996FC/FCX/FHX internal register.

Basic Control Register 0

Used to configure chip settings

CtrlReg_0 **Offset**
Basic Control Register 0 **01_H** **Reset Value**
040F_H

	15	14	13		10	9	8	7	6	5	4	3	2	1	0
	CAM	FSE		PV		PP	PPE	TV	PD	OT	DUP	OPS	AN	FC	
	rw	rw		rw		rw	rw	rw	rw	rw	rw	rw	rw	rw	rw

Field	Bits	Type	Description
CAM	15	rw	Crossover Auto MDIX 0 _B D Disable <i>Note: Hardware Reset latch value EESK can be set globally using the Auto MDIX function.</i> 1 _B E Enable
FSE	14	rw	Fx Select Enable 0 _B TP Tp Mode <i>Note: If this bit has been set to Fx in hardware then the bit does not have the power to change from Fx to Tp</i> 1 _B FX Fx Mode
PV	13 :10	rw	Port VLAN ID
PP	9:8	rw	Port Based Priority
PPE	7	rw	Port Based Priority Enable 0 _B VTE VLAN or TOS Priority Enable <i>Note: This bit is default 0_B to enable VLAN or TOS priority check. If user would like to check the VLAN priority, Tag mode should be enabled.</i> 1 _B PBE Port Based Priority Enable <i>Note: If this bit is set to 1_B, only port based priority will be checked.</i>
TV	6	rw	TOS over VLAN priority 0 _B V VLAN Enable 1 _B T TOS Enable
PD	5	rw	Port Disable 0 _B E Enable 1 _B D Disable
OT	4	rw	Output Packet Tagging 0 _B U Un-tag 1 _B T Tag

Registers Description

Field	Bits	Type	Description
DUP	3	rw	Duplex Enable 0 _B H Half 1 _B F Full
OPS	2	rw	Operating Speed 0 _B 10 10 Mbit/s 1 _B 100 100 Mbit/s
AN	1	rw	Auto-negotiation 0 _B D Disable 1 _B E Enable
FC	0	rw	802.x Flow Control Command 0 _B D Disable 1 _B E Enable

Similar Registers

Table 14 Basic Control Registers 1 to 4

Register Short Name	Register Long Name	Offset Address	Page Number
CtrlReg_P1	Basic Control Register 1	03 _H	
CtrlReg_P2	Basic Control Register 2	05 _H	
CtrlReg_P3	Basic Control Register 3	07 _H	
CtrlReg_P4	Basic Control Register 4	08 _H	
CtrlReg_P5	Basic Control Register 5	09 _H	

Reserved Register 0

Register reserved for future use

ResReg_0	Offset	Reset Value
Reserved Register 0	02_H	040F_H

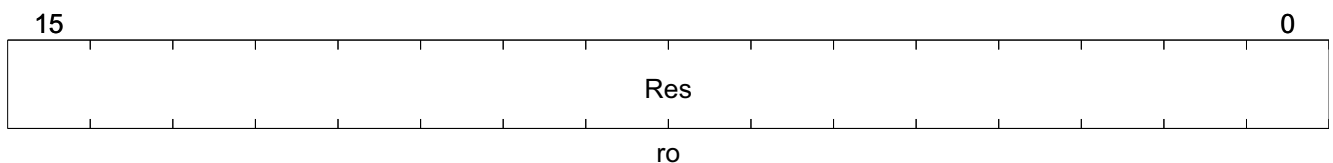

Field	Bits	Type	Description
Res	15:0	ro	Reserved

Similar Registers

Table 15 Reserved Register 1 to 3

Register Short Name	Register Long Name	Offset Address	Page Number
ResReg_1	Reserved Register 1	04 _H	
ResReg_2	Reserved Register 2	06 _H	

Reserved Register 4

Register reserved for future use

ResReg_4	Offset	Reset Value
Reserved Register 4	0A_H	5902_H

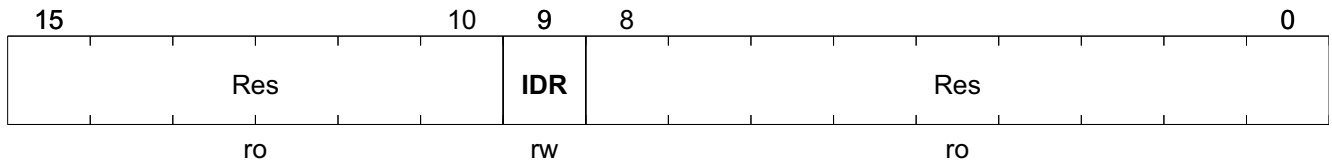

Field	Bits	Type	Description
Res	15:10	ro	Reserved
IDR	9	rw	Replace Packet ID 0 _B N Not replaced 1 _B Y Replaced with 1 by PVID
Res	8:0	ro	Reserved

Configuration Register 1

Used to configure the chip

ConfigReg_1	Offset	Reset Value
Configuration Register 1	0B_H	8000_H

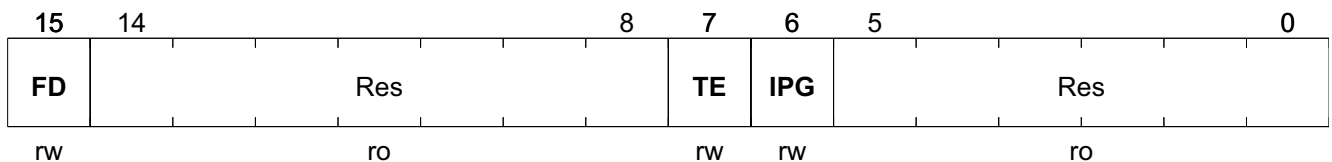

Field	Bits	Type	Description
FD	15	rw	Far End Fault Detection 0 _B D Disable 1 _B E Enable
Res	14:8	ro	Reserved
TE	7	rw	Trunk Enable 0 _B D Disable Trunk of Port 3 and 4 1 _B E Enable Trunk of Port 3 and 4
IPG	6	rw	Inter Packet Gap Setting 0 _B 96B 96 bits 1 _B 92B 92 bits
Res	5:0	ro	Reserved

Reserved Register 5

Reserved for future use

Registers Description

ResReg_5	Offset	Reset Value
Reserved Register 5	0C_H	FA50_H

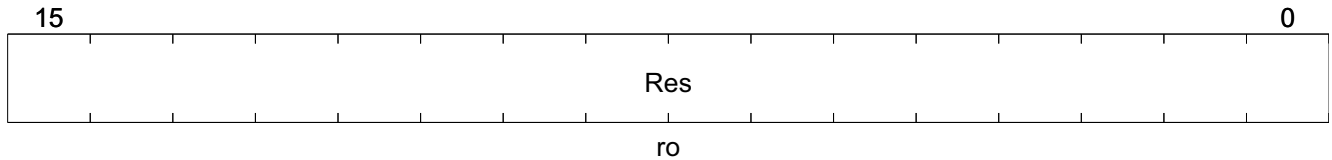

Field	Bits	Type	Description
Res	15:0	ro	Reserved

Similar Registers

Table 16 Reserved Register 6

Register Short Name	Register Long Name	Offset Address	Page Number
ResReg_6	Reserved Register 6	0D _H	

VLAN Priority Map Register

Sets the VLAN priorities

VLAN_Map_P	Offset	Reset Value
VLAN priority Map Register	0E_H	5500_H

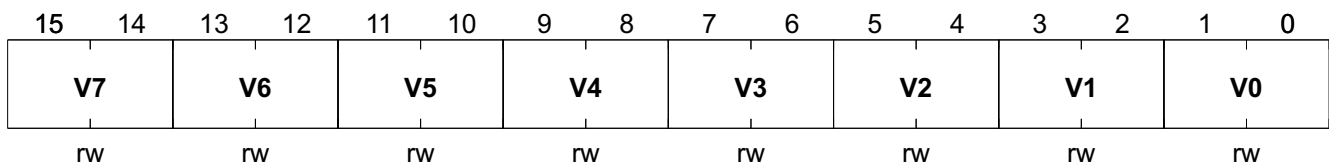

Field	Bits	Type	Description
V7	15:14	rw	Mapped priority of tag value (VLAN)
V6	13:12	rw	
V5	11:10	rw	
V4	9:8	rw	
V3	7:6	rw	
V2	5:4	rw	
V1	3:2	rw	
V0	1:0	rw	

Note: Value 3 ~ 0 are for priority queue Q3~Q0 respectively. The Weight ratio is Q3: Q2: Q1: Q0 = 8: 4: 2: 1. The default is port-base priority for un-tagged packets and non_IP frame.

Type of Service (TOS) Priority Map Register

Sets TOS priority

TOS_Priority **Offset**
TOS priority Map Register **0F_H** **Reset Value**
5500_H

15	14	13	12	11	10	9	8	7	6	5	4	3	2	1	0
T7		T6		T5		T4		T3		T2		T1		T0	
rw		rw		rw		rw		rw		rw		rw		rw	

Field	Bits	Type	Description
T7	15:14	rw	Mapped priority of tag value (TOS)
T6	13:12	rw	
T5	11:10	rw	
T4	9:8	rw	
T3	7:6	rw	
T2	5:4	rw	
T1	3:2	rw	
T0	1:0	rw	

Note: Value 3 ~ 0 are for priority queues Q3~Q0 respectively. The Weight ratio is Q3: Q2: Q1: Q0 = 8: 4: 2: 1. The default is port-based priority for un-tagged packets and non_IP frames.

Configuration Register 2

Used to configure the chip

ConfigReg_2 **Offset**
Configuration Register 2 **10_H** **Reset Value**
0040_H

15	14	13	12	11	10	9	8	7	6	5	4	3	2	1	0
Q3		Q2		Q1		Q0		AGE	Res	Res	XC	Res	SF	ST	
rw		rw		rw		rw		rw	ro	ro	rw	rw	rw	rw	

Field	Bits	Type	Description
Q3	15:14	rw	Discard mode Drop scheme for Queue n. See Table 19 for details on the drop scheme of each queue
Q2	13:12	rw	
Q1	11:10	rw	
Q0	9:8	rw	

Registers Description

Field	Bits	Type	Description
AGE	7	rw	Aging Status 0 _B E Enable 1 _B D Disable
Res	6	ro	Reserved
Res	5	ro	Reserved
XC	4	rw	CRC Check 0 _B E Enable CRC check 1 _B D Disable CRC check
Res	3	rw	Reserved
SF	2	rw	Broadcast Storm Filter 0 _B D Disable 1 _B E Enable
ST	1:0	rw	Broadcast Storm Threshold See below Table 17 and Table 18 for details on the Broadcast Storm Threshold

Note: Broadcast storm initial time interval = 50ms. The max. packet number = 7490 in 100Base, 749 in 10Base

Table 17 The max. packet number = 7490 in 100Base, 749 in 10Base

Per Port Rising Threshold

	00 _B	01 _B	10 _B	11 _B
All 100TX	Disable	14880fps	29760fps	59520fps
Not All 100TX	Disable	1488fps	2976fps	5952fps

Table 18 The max. packet number = 7490 in 100Base, 749 in 10Base

Per Port Falling Threshold

	00 _B	01 _B	10 _B	11 _B
All 100TX	Disable	7440fps	14880fps	29760fps
Not All 100TX	Disable	744fps	1488fps	2976fps

Table 19 Drop Scheme for Each Queue

Discard Mode Utilization	00	01	10	11
TBD	0%	0%	25%	50%

VLAN mode select Register

Selects VLAN Mode

VLAN_Mode	Offset	Reset Value
VLAN Mode Select Register	11_H	FF00_H

Registers Description

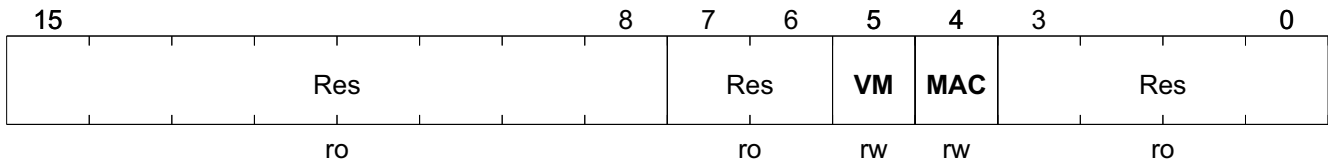

Field	Bits	Type	Description
Res	15:8	ro	Reserved
Res	7:6	ro	Reserved
VM	5	rw	VLAN Mode Select 0 _B P Port based by-pass mode 1 _B Q 802.1Q based
MAC	4	rw	MAC Clone Enable 0 _B N Normal Mode.Learning with SA only. The MAC table will be searched or filled using only SA or DA. 1 _B M Mac Mode. Learned using SA VID0. MAC table will be searched or filled using VID0 SA or DA. This bit allows two identical addresses with different VID0 to be learned.
Res	3:0	ro	Reserved

Note:

Below is an example of a VLAN Tag and a MAC application for Bit4 and Bit5.

Below is an old router architecture example. The disadvantages of this are:

1. WAN port only supports 10M Half-Duplex and non-MDIX functions
2. Needs extra 10M NIC costs.
3. ISA bus will become a bottleneck for the whole system

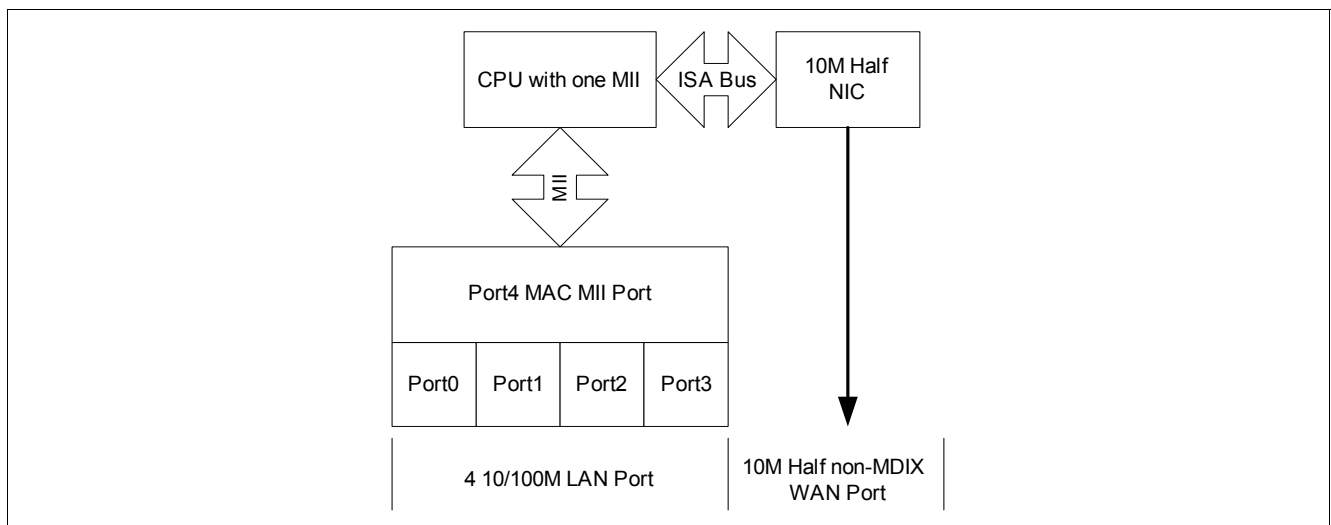

Figure 10 Old Router Architecture Example

Below is new architecture by using ADM6996FC/FCX/FHX serial chip VLAN function. The advantages of below are:

1. WAN Port can upgrade to 100/10 Full/Half, Auto MDIX.
2. WAN/LAN Port is programmable and put on same Switch.
3. No need extra NIC and save lot of costs.
4. High bandwidth of MII port up to 200M speed.

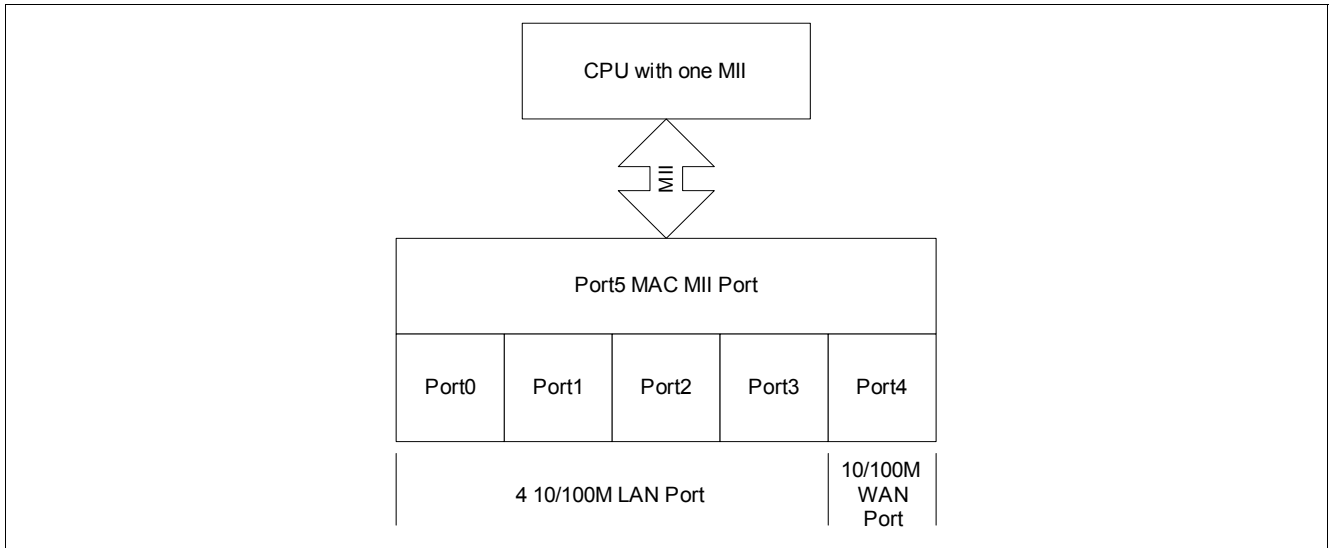

Figure 11 New Router Architecture Using ADM6996FC/FCX/FHX

New Router application works well on normal application. If user's ISP vendor (cable modem) locks Registration Card's ID then Router CPU must send this Lock Registration Card's ID to WAN Port. One condition that may occur is that two same MAC ID exist on this Switch. One is the original Card and the other one is the CPU. This will cause errors in the switch learning table.

ADM6996FC/FCX/FHX provides a MAC Clone function that allows two of the same MAC addresses with different VLAN ID0 in the learning table. This will solve the Lock registration Card's ID issue. ADM6996 series chip will put these two same MAC addresses with different VLAN ID0 at different learning table entry.

How to Set ADM6996FC/FCX/FHX on Router

Port0~3: LAN Port.

Port4: WAN Port.

Port5: MII Port as CPU Port.

Step1: Set Register 0x11h bit4 and bit5 to 1.

{Coding: Write Register 0x11h as 0xff30h}

Step2: Set Port0~3 as Untag Port and set PVID=1.

{Coding: Write Register 0x01h, 0x03h, 0x05h, 0x07h as 0x840f. Port0~3 as Untag, PVID=1, Enable MDIX}

Step3: Set Port4 as Untag Port and set PVID=2.

{Coding: Write Register 0x08h as 0x880fh. Port4 as Untag, PVID=2, Enable MDIX.}

Step4: Set Port5 MII Port as Tag Port and set PVID=2.

{Coding: Write Register 0x09h as 0x881fh. Port5 MII port as Tag, PVID=2.}

Step5: Group Port0, 1, 2, 3, 5 as VLAN 1.

{Coding: Write Register 0x14h as 0x0155h. VLAN1 cover Port0, 1, 2, 3, 5.}

Step6: Group Port4, 5 as VLAN 2.

{Coding: Write Register 0x15h as 0x0180h. VLAN2 cover Port4, 5.}

How MAC Clone Operation

- LAN to LAN/CPU Traffic.

ADM6996FC/FCX/FHX LAN traffic to LAN/CPU only. Traffic to another LAN port will be untag packet. Traffic to CPU is Tag packet with VID=1. CPU can check VID to distinguish LAN traffic or WAN traffic.

- WAN to CPU Traffic.

ADM6996FC/FCX/FHX WAN traffic to CPU only. Traffic to CPU is Tag packet with VID=2. CPU can check VID to distinguish LAN traffic or WAN traffic.

- CPU to LAN Packet.

ADM6996FC/FCX/FHX CPU Packet to LAN port must add VID=1 in VLAN field.

ADM6996FC/FCX/FHX checks VID to distinguish LAN traffic or WAN traffic. LAN output packet is Untag.

- CPU to WAN Packet.

ADM6996FC/FCX/FHX CPU Packet to WAN port must add VID=2 in VLAN filed.

ADM6996FC/FCX/FHX checks VID to distinguish LAN traffic or WAN traffic. WAN output packet is Untag.

- ADM6996FC/FCX/FHX learning sequence

ADM6996FC/FCX/FHX will check VLAN map setting first then check learning table.

User doesn't need to worry LAN/WAN traffic mix up.

Bit 10: Half Duplex Back Pressure enable. 1/enable, 0/disable.

Configuration Register 3

ConfigReg_3	Offset	Reset Value
Miscellaneous Configuration Register 3	12_H	3600_H

15	14	13	12	11	10	9	8	7	6	5	4	3	2	1	0
CD	DUP COL^{SE}	Res	Res	Res	ML5	ML4	ML3	Res	ML2	Res	ML1	Res	ML0		
rw	rw	rw	rw	rw	rw	rw	rw	rw	rw	rw	rw	rw	rw	rw	

Field	Bits	Type	Description
CD	15	rw	Excessive Collision Drop 0 _B D Disable 1 _B E Enable
DUP_COL_SE P	14	rw	Duplex and Col Separate 0 _B D Indicate the duplex and collision status at the same time 1 _B LM Indicate the duplex status only
Res	13:12	rw	Reserved
Res	11	rw	Reserved
Res	10:9	rw	Reserved
ML5	8	rw	Port5 MAC Lock 0 _B D Disable 1 _B LM Lock first MAC Source Address

Registers Description

Field	Bits	Type	Description
ML4	7	rw	Port4 MAC Lock 0 _B D Disable 1 _B LM Lock first MAC Source Address
ML3	6	rw	Port3 MAC Lock 0 _B D Disable 1 _B LM Lock first MAC Source Address
Res	5	rw	Reserved
ML2	4	rw	Port 2 MAC Lock 0 _B D Disable 1 _B LM Lock first MAC source address
Res	3	rw	Reserved
ML1	2	rw	Port1 MAC Lock 0 _B D Disable 1 _B LM Lock first MAC source address
Res	1	rw	Reserved
ML0	0	rw	Port0 MAC Lock 0 _B D Disable 1 _B LM Lock first MAC source address

VLAN Mapping Table Registers 0

VLAN_Map_0 **Offset**
VLAN mapping table registers 0 **13_H** **Reset Value**
FFFF_H

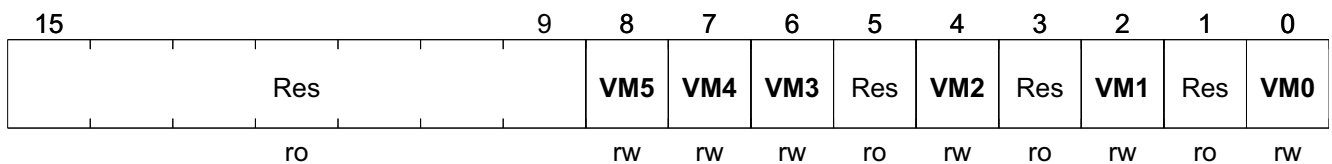

Field	Bits	Type	Description
Res	15:9	ro	Reserved
VM5	8	rw	Port 5 VLAN Mapping 0 _B NM Port 5 is not the member of the VLAN. 1 _B M Port 5 is the member of the VLAN.
VM4	7	rw	Port 4 VLAN Mapping 0 _B NM Port 4 is not the member of the VLAN. 1 _B M Port 4 is the member of the VLAN.
VM3	6	rw	Port 3 VLAN Mapping 0 _B NM Port 3 is not the member of the VLAN. 1 _B M Port 3 is the member of the VLAN.
Res	5	ro	Reserved

Registers Description

Field	Bits	Type	Description
VM2	4	rw	Port 2 VLAN Mapping 0 _B NM Port 2 is not the member of the VLAN. 1 _B M Port 2 is the member of the VLAN.
Res	3	ro	Reserved
VM1	2	rw	Port 1 VLAN Mapping 0 _B NM Port 1 is not the member of the VLAN. 1 _B M Port 1 is the member of the VLAN.
Res	1	ro	Reserved
VM0	0	rw	Port 0 VLAN Mapping 0 _B NM Port 0 is not the member of the VLAN. 1 _B M Port 0 is the member of the VLAN.

Note: 16 VLAN Group: See Register 0x2ch bit 11. Select the VLAN group ports and set the corresponding bits to 1.

Similar Registers

Table 20 Basic Control Registers 1 to 4

Register Short Name	Register Long Name	Offset Address	Page Number
VLAN_Map_1	VLAN mapping table registers 1	14 _H	
VLAN_Map_2	VLAN mapping table registers 2	15 _H	
VLAN_Map_3	VLAN mapping table registers 3	16 _H	
VLAN_Map_4	VLAN mapping table registers 4	17 _H	
VLAN_Map_5	VLAN mapping table registers 5	18 _H	
VLAN_Map_6	VLAN mapping table registers 6	19 _H	
VLAN_Map_7	VLAN mapping table registers 7	1A _H	
VLAN_Map_8	VLAN mapping table registers 8	1B _H	
VLAN_Map_9	VLAN mapping table registers 9	1C _H	
VLAN_Map_10	VLAN mapping table registers 10	1D _H	
VLAN_Map_11	VLAN mapping table registers 11	1E _H	
VLAN_Map_12	VLAN mapping table registers 12	1F _H	
VLAN_Map_13	VLAN mapping table registers 13	20 _H	
VLAN_Map_14	VLAN mapping table registers 14	21 _H	
VLAN_Map_15	VLAN mapping table registers 15	22 _H	

Reserved Register 7

ResReg_7	Offset	Reset Value
Reserved Register 7	23_H	0000_H

Registers Description

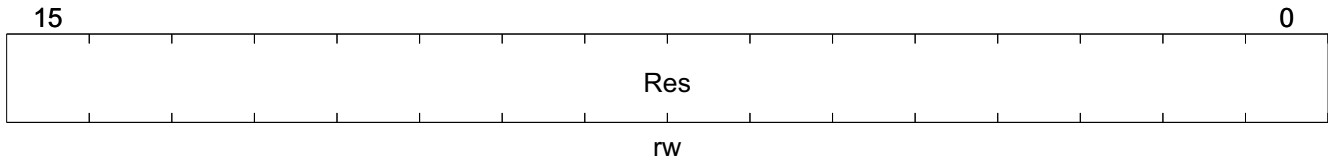

Field	Bits	Type	Description
Res	15:0	rw	Reserved

Similar Registers

Table 21 Reserved Register 8 to 11

Register Short Name	Register Long Name	Offset Address	Page Number
ResReg_8	Reserved Register 8	24 _H	
ResReg_9	Reserved Register 9	25 _H	
ResReg_10	Reserved Register 10	26 _H	
ResReg_11	Reserved Register 11	27 _H	

Configuration Register 4

ConfigReg_4	Offset	Reset Value
Configuration Register 4	28_H	0000_H

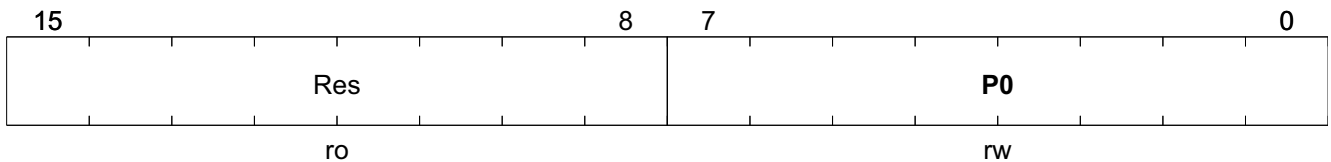

Field	Bits	Type	Description
Res	15:8	ro	Reserved
P0	7:0	rw	Port 0 PVID 0001 _H PVID These 8 bits combine with the register in the hex values bit's [13~10] as the full 12 bits of the VID.

Configuration Register 5

ConfigReg_5	Offset	Reset Value
Configuration Register 5	29_H	0000_H

Registers Description

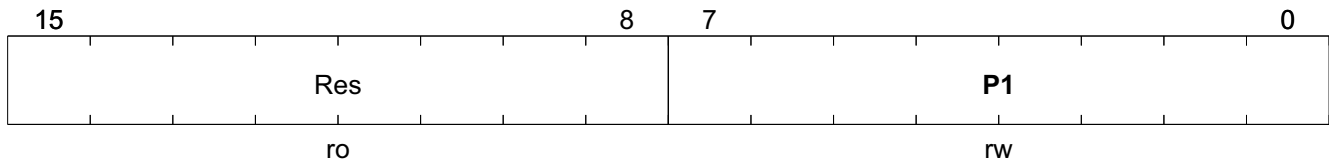

Field	Bits	Type	Description
Res	15:8	ro	Reserved
P1	7:0	rw	Port1 PVID bit 11~4. 0003 _H PVID 1 These 8 bits combine with the register in the hex values bit's [13~10] as the full 12 bits of the VID.

Configuration Register 6

ConfigReg_6	Offset	Reset Value
Configuration Register 6	2A _H	0000 _H

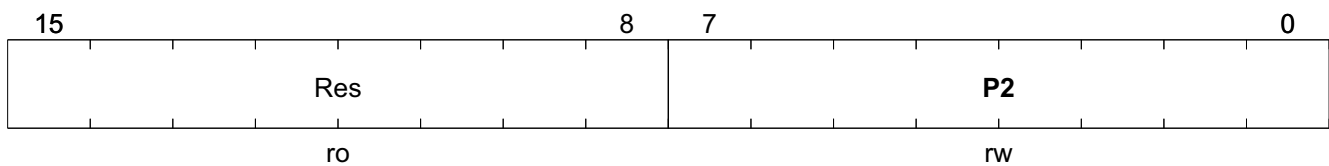

Field	Bits	Type	Description
Res	15:8	ro	Reserved
P2	7:0	rw	Port2 PVID bit 11~4. 0005 _H PVID 2 These 8 bits combine with the register in the hex values bit's [13~10] as the full 12 bits of the VID.

Configuration Register 7

ConfigReg_7	Offset	Reset Value
Configuration Register 7	2B _H	0000 _H

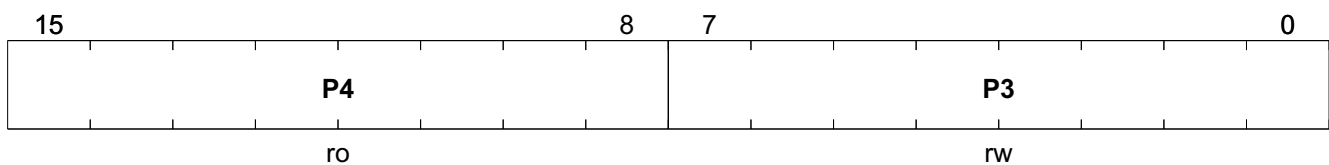

Field	Bits	Type	Description
P4	15:8	ro	Port4 PVID bit 11~4. 0008 _H PVID 1 These 8 bits combine with the register in the hex values bit's [13~10] as the full 12 bits of the VID.

Registers Description

Field	Bits	Type	Description
P3	7:0	rw	Port3 PVID bit 11~4. 0007 _H PVID 1 These 8 bits combine with the register in the hex values bit's [13~10] as the full 12 bits of the VID.

Configuration Register 8

ConfigReg_8 **Offset**
Configuration Register **2C_H** **Reset Value**
D000_H

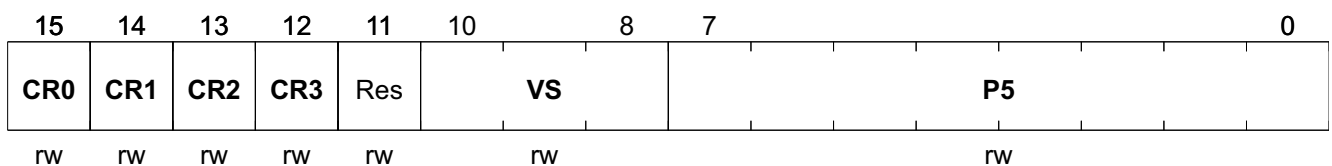

Field	Bits	Type	Description
CR0	15	rw	Control Reserved MAC Control reserved MAC (0180C2000000) 0 _B D Discard 1 _B F Forward
CR1	14	rw	Control Reserved MAC Control reserved MAC (0180C2000001) 0 _B D Discard 1 _B F Forward
CR2	13	rw	Control Reserved MAC Control reserved MAC (0180C2000002- 0180C200000F) 0 _B D Discard 1 _B F Forward
CR3	12	rw	Control Reserved MAC Control reserved MAC (0180C2000010-0180C20000FF) 0 _B D Discard 1 _B F Forward
Res	11	rw	Reserved
VS	10:8	rw	VLAN Grouping Tag Shift 0 _D VID0 VID [3:0] 1 _D VID1 VID [4:1] 2 _D VID2 VID [5:2] 3 _D VID3 VID [6:3] 4 _D VID4 VID [7:4] 5 _D VID5 VID [8:5] 6 _D VID6 VID [9:6] 7 _D VID7 VID [10:7]
P5	7:0	rw	Port5 PVID bit 11~4. 0009 _H PVID 1 These 8 bits combine with the register in the hex values bit's [13~10] as the full 12 bits of the VID.

Note: Bit[10:8]: VLAN Tag shift register. ADM6996FC/FCX/FHX will select 4 bit form total 12 bit VID as VLAN group reference. Bit[15:12]: IEEE 802.3 reserved DA forward or drop police.

Reserved Register 12

ResReg_12	Offset	Reset Value
Reserved Register 12	2D _H	4442 _H

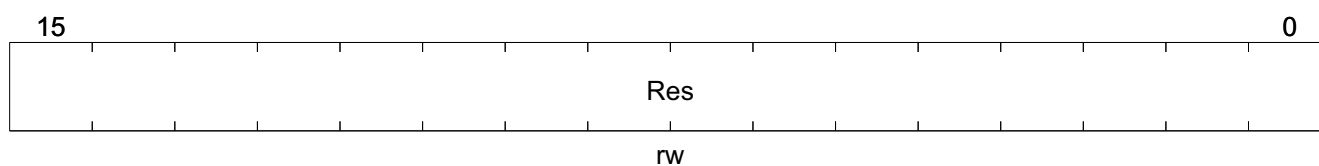

Field	Bits	Type	Description
Res	15:0	rw	Reserved

Reserved Register 13

ResReg_13	Offset	Reset Value
Reserved Register 13	2E _H	0000 _H

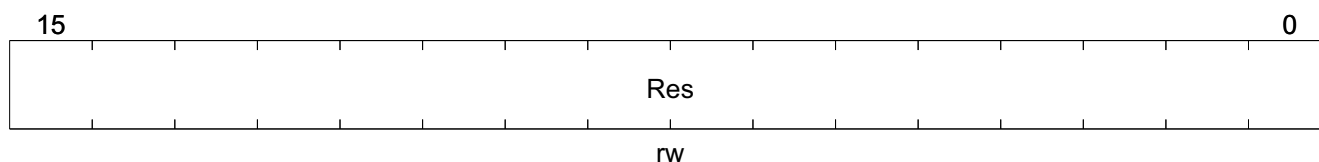

Field	Bits	Type	Description
Res	15:0	rw	Reserved

PHY Restart

PH_Restart	Offset	Reset Value
PHY Restart	2F _H	0000 _H

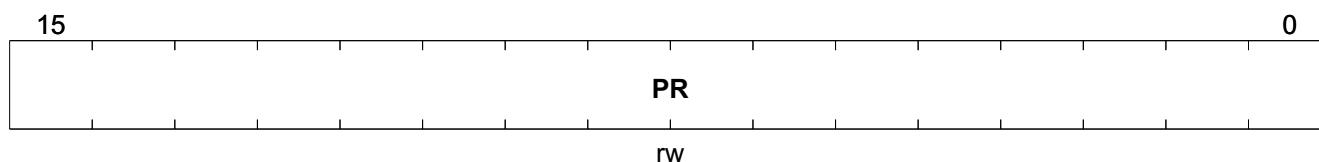

Registers Description

Field	Bits	Type	Description
PR	15:0	rw	PHY Restart 0000 _H PHY Restart Writing this Hex value to this register restarts the internal PHYs.

Configuration Register 9

ConfigReg_
Miscellaneous Configuration Register 9 **Offset**
30_H **Reset Value**
0987_H

15	13	12	11	10	9	8	7	6	5	4	0
Res		LM	Res	Res	DHCOL_L*	Res	Res	RCL	MAC		Res
rw		rw	rw	rw	rw	rw	rw	rw	rw		rw

Field	Bits	Type	Description
Res	15:13	rw	Reserved
LM	12	rw	Port 4 LED Mode 0 _B D LinkAct/DupCol/Speed 1 _B S LinkAct/Speed
Res	11	rw	Reserved
Res	10	rw	Reserved
DHCOL_LED_EN	9	rw	Dual Speed Hub COL_LED Enable 0 _B N Normal LED display. 1 _B D Dual Speed Hub LED display. Port0 Col LED: 10M Col LED. Port1 Col LED: 100M Col LED.
Res	8	rw	Reserved
Res	7	rw	Reserved
RCL	6	rw	MII Speed Double 0 _B 25 TxCLK max speed is 25 MHz 1 _B 50 TxCLK max speed is 50 MHz
MAC	5	rw	Mac Clone Enable MAC Clone Enable Bit[1].
Res	4:0	rw	Reserved

Bandwidth Control Register

BWCon_0
Bandwidth Control Register 0 **Offset**
31_H **Reset Value**
0000_H

Registers Description

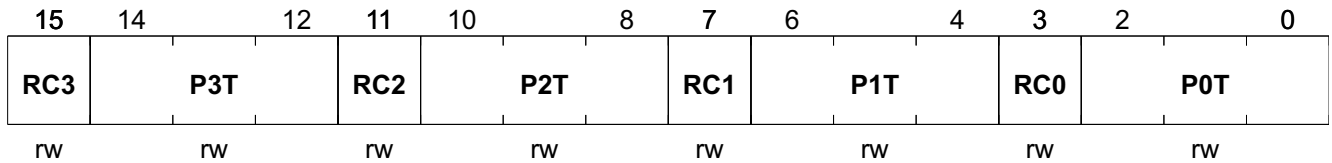

Field	Bits	Type	Description
RC3	15	rw	Receive Packet Length Count Counted on the Source Port 3. 0 _D R3 The switch will add length to the P3 counter
P3T	14:12	rw	Port 3 Threshold Control Meter Reference Table 22 in note below.
RC2	11	rw	Receive Packet Length Count Counted on the Source Port 2. 0 _D R2 The switch will add length to the P2 counter
P2T	10:8	rw	Port 2 Threshold Control Meter Reference Table 22 in note below.
RC1	7	rw	Receive Packet Length Count Counted on the Source Port 1. 0 _D R1 The switch will add length to the P1 counter
P1T	6:4	rw	Port 1 Threshold Control Meter Reference Table 22 in note below.
RC0	3	rw	Receive Packet Length Count Counted on the Source Port 0. 0 _D R0 The switch will add length to the P2 counter
P0T	2:0	rw	Port 0 Threshold Control Meter Reference Table 22 in note below.

Table 22 Note: Reference Table

000	001	010	011	100	101	110	111
256K	512K	1M	2M	5M	10M	20M	50M

Bandwidth Control Register 1

BWCon_1	Offset	Reset Value
Bandwidth Control Register 1	32_H	0000_H

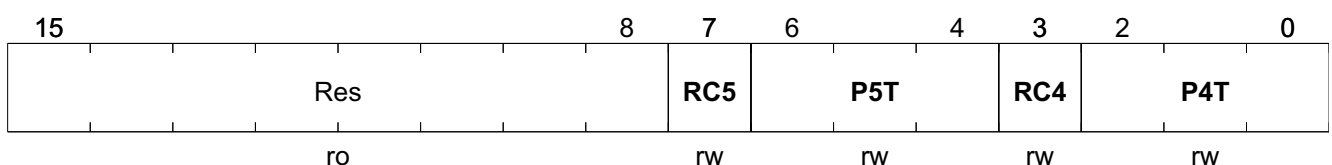

Registers Description

Field	Bits	Type	Description
Res	15:8	ro	Reserved
RC5	7	rw	Receive Packet Length Count Counted on the Source Port 5. 0 _D Count5 The switch will add length to the P5 counter
P5T	6:4	rw	Port 5 Threshold Control Meter Reference Table 22 in note below.
RC4	3	rw	Receive Packet Length Count Counted on the Source Port 4. 0 _D Count4 The switch will add length to the P4 counter
P4T	2:0	rw	Port 4 Threshold Control Meter Reference Table 22 in note below.

Bandwidth Control Enable Register

BWConEn **Offset** **Reset Value**
Bandwidth Control Enable Register **33_H** **0000_H**

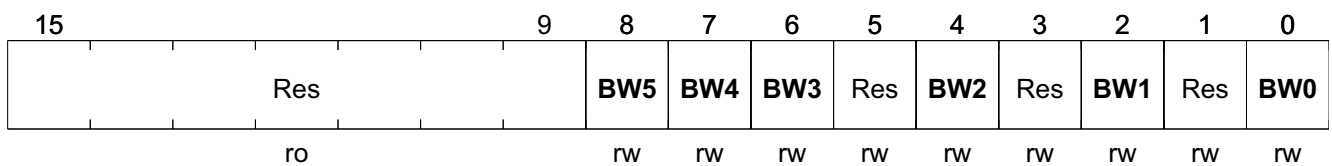

Field	Bits	Type	Description
Res	15:9	ro	Reserved
BW5	8	rw	Port 5 Bandwidth Control Enable 0 _B D Disable 1 _B E Enable
BW4	7	rw	Port 4 Bandwidth Control Enable 0 _B D Disable 1 _B E Enable
BW3	6	rw	Port 3 Bandwidth Control Enable 0 _B D Disable 1 _B E Enable
Res	5	rw	Reserved
BW2	4	rw	Port 2 Bandwidth Control Enable 0 _B D Disable 1 _B E Enable
Res	3	rw	Reserved
BW1	2	rw	Port 1 Bandwidth Control Enable 0 _B D Disable 1 _B E Enable
Res	1	rw	Reserved

Registers Description

Field	Bits	Type	Description
BW0	0	rw	Port 0 Bandwidth Control Enable 0 _B D Disable 1 _B E Enable

4.2 Serial Register

Table 23 Registers Address Space

Module	Base Address	End Address	Note
EEPROM	00 _H	3C _H	Independent Address Space

Table 24 Registers Overview

Register Short Name	Register Long Name	Offset Address	Page Number
ChipID	Chip Identifier Register	00 _H	71
PortStat_0	Port Status Register 0	01 _H	71
PortStat_1	Port Status Register 1	02 _H	73
CabStat	Cable Broken Status	03 _H	74
P0_RP_CNT	Port 0 Receive Packet Count	04 _H	75
P1_RP_CNT	Port 1 Receive Packet Count	06 _H	75
P2_RP_CNT	Port 2 Receive Packet Count	08 _H	75
P3_RP_CNT	Port 3 Receive Packet Count	0A _H	75
P4_RP_CNT	Port 4 Receive Packet Count	0B _H	75
P5_RP_CNT	Port 5 Receive Packet Count	0C _H	75
P0_RB_CNT	Port 0 Receive Byte Count	0D _H	75
P1_RB_CNT	Port 1 Receive Byte Count	0F _H	75
P2_RB_CNT	Port 2 Receive Byte Count	11 _H	75
P3_RB_CNT	Port 3 Receive Byte Count	13 _H	75
P4_RB_CNT	Port 4 Receive Byte Count	14 _H	75
P5_RB_CNT	Port 5 Receive Byte Count	15 _H	75
P0_TP_CNT	Port 0 Transmit Packet Count	16 _H	75
P1_TP_CNT	Port 1 Transmit Packet Count	18 _H	75
P2_TP_CNT	Port 2 Transmit Packet Count	1A _H	75
P3_TP_CNT	Port 3 Transmit Packet Count	1C _H	75
P4_TP_CNT	Port 4 Transmit Packet Count	1D _H	75
P5_TP_CNT	Port 5 Transmit Packet Count	1E _H	75
P0_TB_CNT	Port 0 Transmit Byte Count	1F _H	76
P1_TB_CNT	Port 1 Transmit Byte Count	21 _H	76
P2_TB_CNT	Port 2 Transmit Byte Count	23 _H	76
P3_TB_CNT	Port 3 Transmit Byte Count	25 _H	76
P4_TB_CNT	Port 4 Transmit Byte Count	26 _H	76
P5_TB_CNT	Port 5 Transmit Byte Count	27 _H	76
P0_COL_CNT	Port 0 Collision Count	28 _H	76
P1_COL_CNT	Port 1 Collision Count	2A _H	76
P2_COL_CNT	Port 2 Collision Count	2C _H	76
P3_COL_CNT	Port 3 Collision Count	2E _H	76
P4_COL_CNT	Port 4 Collision Count	2F _H	76
P5_COL_CNT	Port 5 Collision Count	30 _H	76

Table 24 Registers Overview (cont'd)

Register Short Name	Register Long Name	Offset Address	Page Number
P0_ERR_CNT	Port 0 Error Count	31 _H	76
P1_ERR_CNT	Port 1 Error Count	33 _H	76
P2_ERR_CNT	Port 2 Error Count	35 _H	76
P3_ERR_CNT	Port 3 Error Count	37 _H	76
P4_ERR_CNT	Port 4 Error Count	38 _H	76
P5_ERR_CNT	Port 5 Error Count	39 _H	76
OverFlow_0	Over Flow Flag Register 0	3A _H	76
OverFlow_1	Over Flow Flag Register 1	3B _H	77
OverFlow_2	Over Flow Flag Register 2	3C _H	78

The register is addressed wordwise.

For Register Access Types refer to [Table 12 “Register Access Types” on Page 49](#).

Table 25 Registers Clock Domains

Clock Short Name	Description
–	–

4.2.1 Serial Register Map

Chip Identifier Register

ChipID	Offset	Reset Value
Chip Identifier Register	00 _H	0007 1023 _H

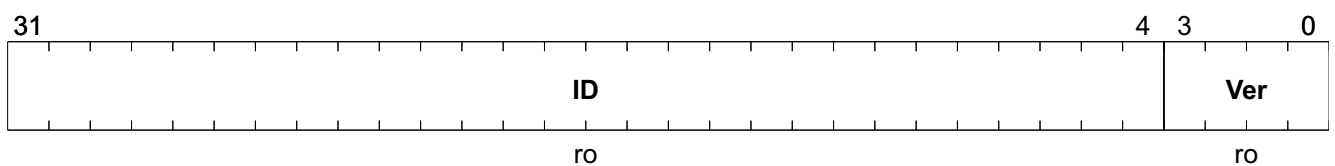

Field	Bits	Type	Description
ID	31:4	ro	Chip Identifier Register 000 7102 _H ID Chip Identifier
Ver	3:0	ro	Version No 2 _H Ver Version No.

Port Status Register 0

PortStat_0	Offset	Reset Value
Port Status Register 0	01 _H	0000 0000 _H

Registers Description

31	30	29	28	27	26	25	24	23	22	21	20	19	18	17	16	15	14	13	12	11	10	9	8	7	6	5	4	3	2	1	0
FP4	DP4	SP4	LP4	FP3	DP3	SP3	LP3	Res	Res	Res	Res	FP2	DP2	SP2	LP2	Res	Res	Res	Res	FP1	DP1	SP1	LP1	Res	Res	Res	Res	FP0	DP0	SP0	LP0
ro	ro	ro	ro	ro	ro	ro	ro	ro	ro	ro	ro	ro	ro	ro	ro	ro	ro	ro	ro	ro	ro	ro	ro	ro	ro	ro	ro	ro	ro	ro	ro

Field	Bits	Type	Description
FP4	31	ro	Port 4 Flow Control Enable 0 _B D Flow Control Disable 1 _B FC4 802.3X on for full duplex or back pressure on for half duplex.
DP4	30	ro	Port 4 Duplex Status 0 _B H Half Duplex 1 _B F Full Duplex
SP4	29	ro	Port 4 Speed Status 0 _B 10 10 Mbit/s 1 _B 100 100 Mbit/s
LP4	28	ro	Port 4 Linkup Status 0 _B NE Link is not established. 1 _B E Link is established.
FP3	27	ro	Port 3 Flow Control Enable 0 _B D Flow Control Disable 1 _B FC3 802.3X on for full duplex or back pressure on for half duplex.
DP3	26	ro	Port 3 Duplex Status 0 _B H Half Duplex 1 _B F Full Duplex
SP3	25	ro	Port 3 Speed Status 0 _B 10 10 Mbit/s 1 _B 100 100 Mbit/s
LP3	24	ro	Port 3 Linkup Status Port 3 Linkup Status: 0 _B N Link is not established. 1 _B E Link is established.
Res	23	ro	Reserved
Res	22	ro	Reserved
Res	21	ro	Reserved
Res	20	ro	Reserved
FP2	19	ro	Port 2 Flow Control Enable 0 _B D Flow Control Disable 1 _B FC2 802.3X on for full duplex or back pressure on for half duplex.
DP2	18	ro	Port 2 Duplex Status 0 _B H Half Duplex 1 _B F Full Duplex
SP2	17	ro	Port 2 Speed Status 0 _B 10 10 Mbit/s 1 _B 100 100 Mbit/s

Registers Description

Field	Bits	Type	Description
LP2	16	ro	Port 2 Linkup Status Port 2 Linkup Status: 0 _B NE Link is not established. 1 _B E Link is established.
Res	15	ro	Reserved
Res	14	ro	Reserved
Res	13	ro	Reserved
Res	12	ro	Reserved
FP1	11	ro	Port 1 Flow Control Enable 0 _B D Flow Control Disable 1 _B FC1 802.3X on for full duplex or back pressure on for half duplex.
DP1	10	ro	Port 1 Duplex Status 0 _B H Half Duplex 1 _B F Full Duplex
SP1	9	ro	Port 1 Speed Status 0 _B 10 10 Mbit/s 1 _B 100 100 Mbit/s
LP1	8	ro	Port 1 Linkup Status 0 _B NE Not established. 1 _B E Established.
Res	7	ro	Reserved
Res	6	ro	Reserved
Res	5	ro	Reserved
Res	4	ro	Reserved
FP0	3	ro	Port 0 Flow Control Enable 0 _B D Flow Control Disable 1 _B FC0 802.3X on for full duplex or back pressure on for half duplex.
DP0	2	ro	Port 0 Duplex Status 0 _B H Half Duplex 1 _B F Full Duplex
SP0	1	ro	Port 0 Speed Status 0 _B 10 10 Mbit/s 1 _B 100 100 Mbit/s
LP0	0	ro	Port 0 Linkup Status 0 _B NE Not established. 1 _B E Established.

Port Status Register 1

PortStat_1	Offset	Reset Value
Port Status Register 1	02_H	0000 0000_H

Registers Description

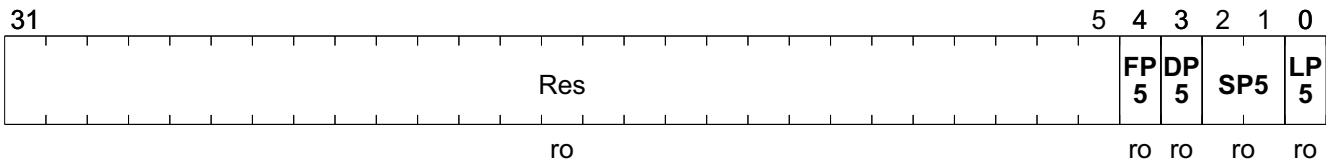

Field	Bits	Type	Description
Res	31:5	ro	Reserved
FP5	4	ro	Port 5 Flow Control Enable 0 _B D Flow Control Disable 1 _B FC5 802.3X on for full duplex or back pressure on for half duplex.
DP5	3	ro	Port 5 Duplex Status 0 _B H Half Duplex 1 _B F Full Duplex
SP5	2:1	ro	Port 5 Speed Status 0 _B 10 10 Mbit/s 1 _B 100 100 Mbit/s
LP5	0	ro	Port 5 Linkup Status 0 _B NE Not established. 1 _B E Established.

Cable Broken Status Register

CabStat	Offset	Reset Value
Cable Broken Status	03_H	0000 0000_H

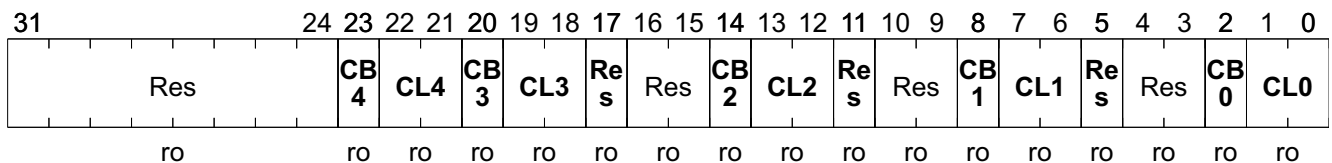

Field	Bits	Type	Description
Res	31:24	ro	Reserved
CB4	23	ro	Port 4 Cable Broken
CL4	22:21	ro	Port 4 Cable Broken Length
CB3	20	ro	Port 3 Cable Broken
CL3	19:18	ro	Port 3 Cable Broken Length
Res	17	ro	Reserved
Res	16:15	ro	Reserved
CB2	14	ro	Port 2 Cable Broken
CL2	13:12	ro	Port 2 Cable Broken Length
Res	11	ro	Reserved
Res	10:9	ro	Reserved

Registers Description

Field	Bits	Type	Description
CB1	8	ro	Port 1 Cable Broken
CL1	7:6	ro	Port 1 Cable Broken Length
Res	5	ro	Reserved
Res	4:3	ro	Reserved
CB0	2	ro	Port 0 Cable Broken
CL0	1:0	ro	Port 0 Cable Broken Length

Port 0 Receive Packet Count

P0_RP_CNT	Offset	Reset Value
Port 0 Receive Packet Count	04_H	0000 0000_H

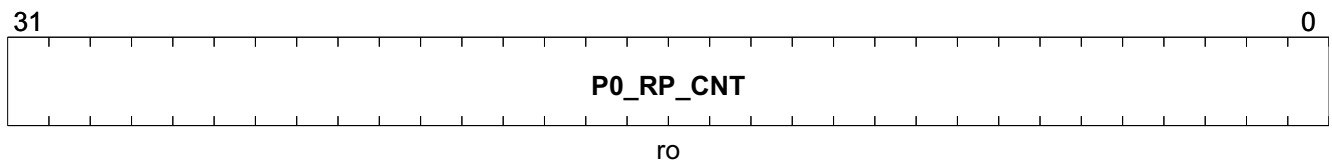

Field	Bits	Type	Description
P0_RP_CNT	31:0	ro	Counter

Similar Registers

Table 26 Per Port Counter

Register Short Name	Register Long Name	Offset Address	Page Number
P1_RP_CNT	Port 1 Receive Packet Count	06 _H	
P2_RP_CNT	Port 2 Receive Packet Count	08 _H	
P3_RP_CNT	Port 3 Receive Packet Count	0A _H	
P4_RP_CNT	Port 4 Receive Packet Count	0B _H	
P5_RP_CNT	Port 5 Receive Packet Count	0C _H	
P0_RB_CNT	Port 0 Receive Byte Count	0D _H	
P1_RB_CNT	Port 1 Receive Byte Count	0F _H	
P2_RB_CNT	Port 2 Receive Byte Count	11 _H	
P3_RB_CNT	Port 3 Receive Byte Count	13 _H	
P4_RB_CNT	Port 4 Receive Byte Count	14 _H	
P5_RB_CNT	Port 5 Receive Byte Count	15 _H	
P0_TP_CNT	Port 0 Transmit Packet Count	16 _H	
P1_TP_CNT	Port 1 Transmit Packet Count	18 _H	
P2_TP_CNT	Port 2 Transmit Packet Count	1A _H	
P3_TP_CNT	Port 3 Transmit Packet Count	1C _H	
P4_TP_CNT	Port 4 Transmit Packet Count	1D _H	
P5_TP_CNT	Port 5 Transmit Packet Count	1E _H	

Registers Description

Table 26 Per Port Counter (cont'd)

Register Short Name	Register Long Name	Offset Address	Page Number
P0_TB_CNT	Port 0 Transmit Byte Count	1F _H	
P1_TB_CNT	Port 1 Transmit Byte Count	21 _H	
P2_TB_CNT	Port 2 Transmit Byte Count	23 _H	
P3_TB_CNT	Port 3 Transmit Byte Count	25 _H	
P4_TB_CNT	Port 4 Transmit Byte Count	26 _H	
P5_TB_CNT	Port 5 Transmit Byte Count	27 _H	
P0_COL_CNT	Port 0 Collision Count	28 _H	
P1_COL_CNT	Port 1 Collision Count	2A _H	
P2_COL_CNT	Port 2 Collision Count	2C _H	
P3_COL_CNT	Port 3 Collision Count	2E _H	
P4_COL_CNT	Port 4 Collision Count	2F _H	
P5_COL_CNT	Port 5 Collision Count	30 _H	
P0_ERR_CNT	Port 0 Error Count	31 _H	
P1_ERR_CNT	Port 1 Error Count	33 _H	
P2_ERR_CNT	Port 2 Error Count	35 _H	
P3_ERR_CNT	Port 3 Error Count	37 _H	
P4_ERR_CNT	Port 4 Error Count	38 _H	
P5_ERR_CNT	Port 5 Error Count	39 _H	

Over Flow Flag Register 0

OverFlow_0 **Offset** **Reset Value**
Over Flow Flag Register 0 **3A_H** **0000 0000_H**

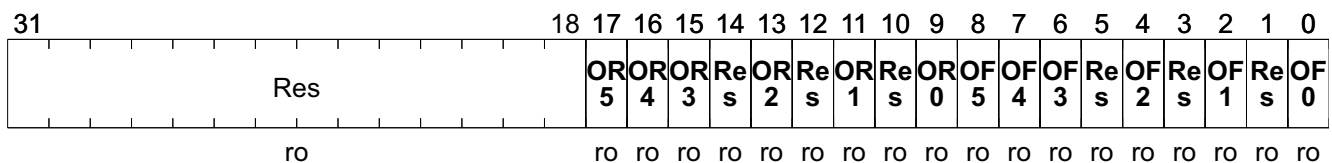

Field	Bits	Type	Description
Res	31:18	ro	Reserved
OR5	17	ro	Overflow of Port 5 Receive Packet Byte Count
OR4	16	ro	Overflow of Port 4 Receive Packet Byte Count
OR3	15	ro	Overflow of Port 3 Receive Packet Byte Count
Res	14	ro	Reserved
OR2	13	ro	Overflow of Port 2 Receive Packet Byte Count
Res	12	ro	Reserved
OR1	11	ro	Overflow of Port 1 Receive Packet Byte Count
Res	10	ro	Reserved
OR0	9	ro	Overflow of Port 0 Receive Packet Byte Count

Registers Description

Field	Bits	Type	Description
OF5	8	ro	Overflow of Port 5 Receive Packet Count
OF4	7	ro	Overflow of Port 4 Receive Packet Count
OF3	6	ro	Overflow of Port 3 Receive Packet Count
Res	5	ro	Reserved
OF2	4	ro	Overflow of Port 2 Receive Packet Count
Res	3	ro	Reserved
OF1	2	ro	Overflow of Port 1 Receive Packet Count
Res	1	ro	Reserved
OF0	0	ro	Overflow of Port 0 Receive Packet Count

Over Flow Flag Register 1

OverFlow_1	Offset	Reset Value
Over Flow Flag Register 1	3B _H	0000 0000 _H

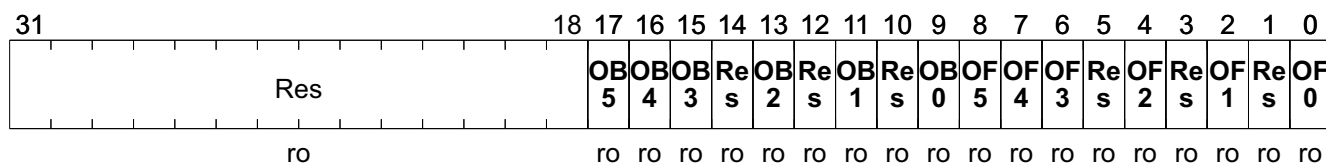

Field	Bits	Type	Description
Res	31:18	ro	Reserved
OB5	17	ro	Overflow of Port 5 Transmit Packet Byte Count
OB4	16	ro	Overflow of Port 4 Transmit Packet Byte Count
OB3	15	ro	Overflow of Port 3 Transmit Packet Byte Count
Res	14	ro	Reserved
OB2	13	ro	Overflow of Port 2 Transmit Packet Byte Count
Res	12	ro	Reserved
OB1	11	ro	Overflow of Port 1 Transmit Packet Byte Count
Res	10	ro	Reserved
OB0	9	ro	Overflow of Port 0 Transmit Packet Byte Count
OF5	8	ro	Overflow of Port 5 Transmit Packet Count
OF4	7	ro	Overflow of Port 4 Transmit Packet Count
OF3	6	ro	Overflow of Port 3 Transmit Packet Count
Res	5	ro	Reserved
OF2	4	ro	Overflow of Port 2 Transmit Packet Count
Res	3	ro	Reserved
OF1	2	ro	Overflow of Port 1 Transmit Packet Count
Res	1	ro	Reserved
OF0	0	ro	Overflow of Port 0 Transmit Packet Count

Table 28 VLAN Packet

Tag Protocol TD 8100	Tag Control Information TCI	LEN Length	Routing Information
Byte 12~13	Byte14~15	Byte 16~17	Byte 18

Note: ADM6996FC/FCX/FHX will check packet byte 12 &13. If byte[12:13]=8100h then this packet is a VLAN packet

Byte 14~15: Tag Control Information TCI

Bit[15:13]: User Priority 7~0

Bit 12: Canonical Format Indicator (CFI)

Bit[11~0]: VLAN ID. The ADM6996FC/FCX/FHX will use bit[3:0] as VLAN group.

4.5 TOS IP Packet

Table 29 IP Packet

Type 0800	IP Header
Byte 12~13	Byte 14~15

Note: ADM6996FC/FCX/FHX checks bytes 12 &13. If this value is 0800h then the ADM6996FC/FCX/FHX knows this is a TOP priority packet.

IP header define

Byte 14

Bit[7:0]: IP protocol version number & header length.

Byte 15: Service type

Bit[7~5]: IP Priority (Precedence) from 7~0

Bit 4: No Delay (D)

Bit 3: High Throughput

Bit 2: High Reliability (R)

Bit[1:0]: Reserved

4.6 EEPROM Access

Users can select ADM6996FC/FCX/FHX to read EEPROM contents as the chip setting or not select. ADM6996FC/FCX/FHX will check the signature of EEPROM, then decide to load contents of EEPROM or not select.

Table 30 RESETL & EEPROM Content Relationship

RESETL	CS	SK	DI	DO
0	High Impedance	High Impedance	High Impedance	High Impedance
Rising edge 01 (30ms)	Output	Output	Output	Input
1 (after 30ms)	Input	Input	Output	Input

Keep at least 30ms after RESETL from 01. ADM6996FC/FCX/FHX will read data from EEPROM. After RESETL if CPU update EEPROM that ADM6996FC/FCX/FHX will update configuration registers too.

When CPU programming EEPROM & ADM6996FC/FCX/FHX, ADM6996FC/FCX/FHX recognizes the EEPROM WRITE instruction only. If there is any Protection instruction before or after the EEPROM WRITE instruction, CPU needs to generate separated CS signal cycle for each Protection & WRITE instruction.

CPU can directly program ADM6996FC/FCX/FHX after 30ms of Reset signal rising edge with or without EEPROM. ADM6996FC/FCX/FHX serial chips will latch hardware-reset value as recommend value. It includes EEPROM interface:

EECS: Internal Pull down 40K resister.

EESK: TP port Auto-MDIX select. Internal pull down 40K resister as non Auto-MDIX mode.

EDI: Dual Color Select. Internal pull down 40K resister as Single Color Mode.

EDO: EEPROM enable. Internal pull up 40K resister as EEPROM enable.

Below Figure is ADM6996FC/FCX/FHX serial chips EEPROM pins operation at different stage. Reset signal is controlled by CPU with at least 100ms low. Point1 is Reset rising edge. CPU must prepare proper value on EECS(0), EESK, EDI, EDO(1) before this rising edge. ADM6996FC/FCX/FHX will read this value into chip at Point2. CPU must keep these values over point2. Point2 is 200ns after Reset rising edge.

ADM6996FC/FCX/FHX serial chips will read EEPROM content at Point4 which are 800ns far away from the rising edge of Reset. CPU must turn EEPROM pins EECS, EESK, EDI and EDO to High-Z or pull high before Point4.

If user want to change state to High-Z or pull high on EEPROM pins, the order is CS-> DI -> DO -> SK is better.

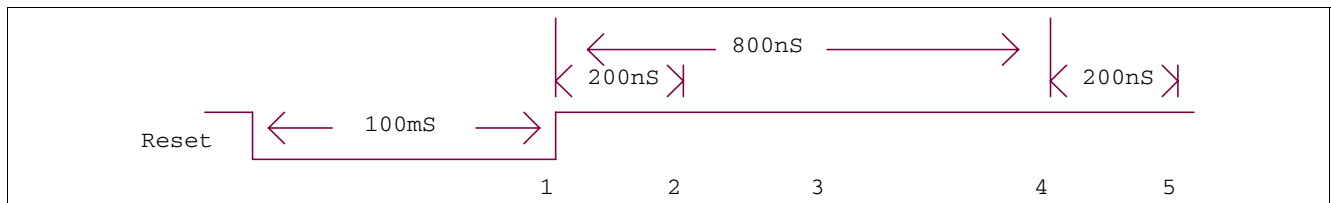

Figure 12 CPU Generated Reset Signal Requirement

Writing EEPROM timing is a little different. See the graph below. Must be careful when CS goes down after a write command, SK must issue at least one clock. This is a difference between ADM6996FC/FCX/FHX with EEPROM write timing. If system without EEPROM then user must write ADM6996FC/FCX/FHX internal register by 93C66 timing. If user uses EEPROM then the writing timing depends on EEPROM type.

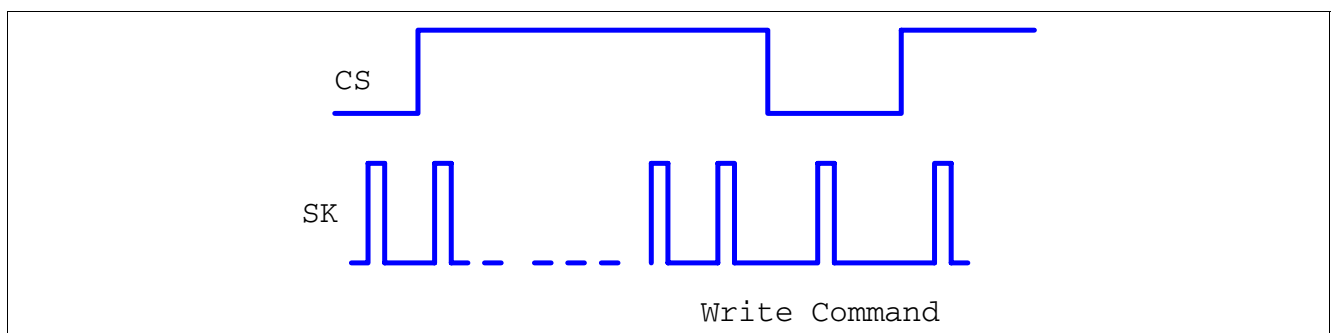

Figure 13 CPU Write EEPROM Command Requirement

4.7 Serial Interface Timing

ADM6996FC/FCX/FHX serial chip's internal counter or EEPROM access timing

EESK: Similar to the MDC signal.

EDI: Similar to the MDIO signal

ECS: Must keep be kept low.

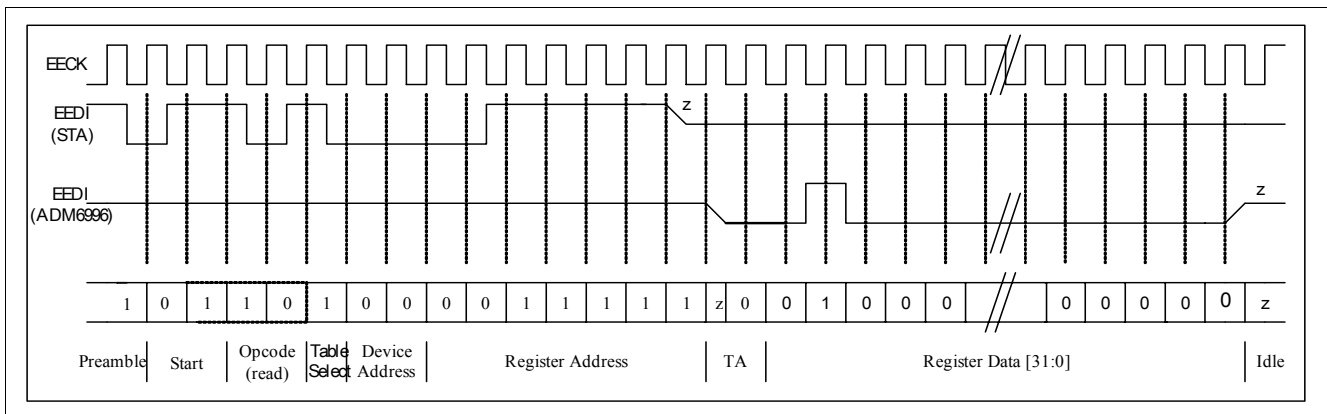

Figure 14 Serial Interface Read Command Timing

Preamble: At least 32 continuous 1_B's

Start: 01_B(2 bits)

Opcode: 10_B (2 bits, Only supports a read command)

Table select: 1_B = Counter, 0_B = EEPROM (1 bit)

Register Address: Read Target register address. (7 bits)

TA: Turn Around.

Register Data: 32 bit data.

Counter output bit sequence is bit 31 to bit 0.

If a user reads the EEPROM then 32 bits of data will be separated in two EEPROM registers. The sequence is:

1. Register +1, Register (Register is even number)
2. Register, Register-1(Register is Odd number)

Example:

Read Register 00_H then the ADM6996FC/FCX/FHX will drive 01_H & 00_H

Read Register 03_H then ADM6996FC/FCX/FHX will drive 03_H & 02_H

Idle: EESK must send at least one clock pulse at idle time

ADM6996FC/FCX/FHX issue Reset internal counter command

EESK: Similar to the MDC signal

EDI: Similar to the MDIO signal

ECS: Must keep low.

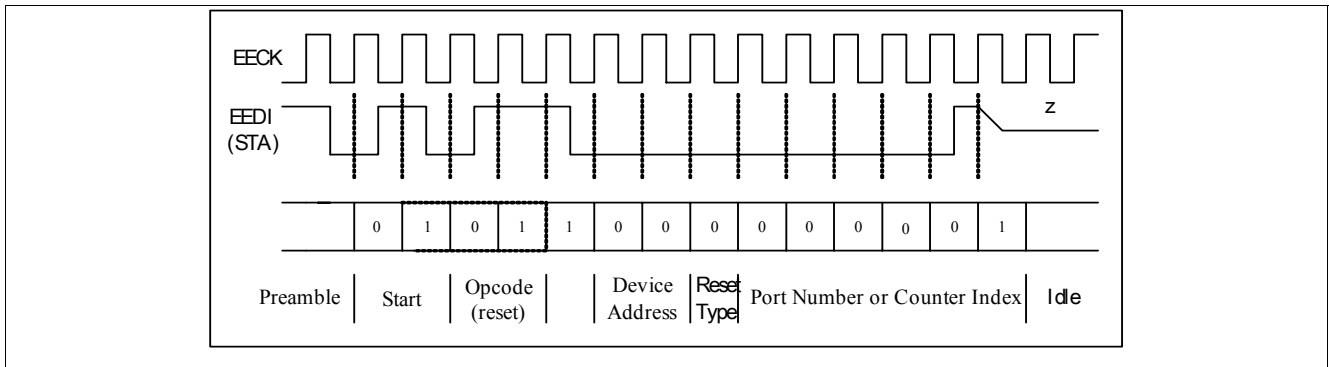

Figure 15 Serial Interface Reset Command Timing

Preamble: At least 32 continuous 1_B's

Start: 01_B(2 bits)

Opcode: 01_B (2 bits, Reset command)

Device Address: Chip physical address as PHYAS[1:0].

Reset_type: Reset the counter by port number or by counter index

1_B = Clear dedicate port's all counters

0_B = Clear dedicate counter

Port_number or counter index: User defines clear port or counter

Idle: EESK must send at least one clock pulse at idle time

Generated Registers Overview

Table 31 Registers Overview

Register Short Name	Register Long Name	Offset Address	Page Number
EEPROM Register (0x0b[0]=0)			
SigReg	Signature Register	00 _H	50
CtrlReg_0	Basic Control Register 0	01 _H	51
ResReg_0	Reserved Register 0	02 _H	52
CtrlReg_P1	Basic Control Register 1	03 _H	52
ResReg_1	Reserved Register 1	04 _H	52
CtrlReg_P2	Basic Control Register 2	05 _H	52
ResReg_2	Reserved Register 2	06 _H	52
CtrlReg_P3	Basic Control Register 3	07 _H	52
CtrlReg_P4	Basic Control Register 4	08 _H	52
CtrlReg_P5	Basic Control Register 5	09 _H	52
ResReg_4	Reserved Register 4	0A _H	53
ConfigReg_1	Configuration Register 1	0B _H	53
ResReg_5	Reserved Register 5	0C _H	53
ResReg_6	Reserved Register 6	0D _H	54
VLAN_Map_P	VLAN priority Map Register	0E _H	54
TOS_Priority	TOS priority Map Register	0F _H	55
ConfigReg_2	Configuration Register 2	10 _H	55
VLAN_Mode	VLAN Mode Select Register	11 _H	56
ConfigReg_3	Miscellaneous Configuration Register 3	12 _H	59
VLAN_Map_0	VLAN mapping table registers 0	13 _H	60
VLAN_Map_1	VLAN mapping table registers 1	14 _H	61
VLAN_Map_2	VLAN mapping table registers 2	15 _H	61
VLAN_Map_3	VLAN mapping table registers 3	16 _H	61
VLAN_Map_4	VLAN mapping table registers 4	17 _H	61
VLAN_Map_5	VLAN mapping table registers 5	18 _H	61
VLAN_Map_6	VLAN mapping table registers 6	19 _H	61
VLAN_Map_7	VLAN mapping table registers 7	1A _H	61
VLAN_Map_8	VLAN mapping table registers 8	1B _H	61
VLAN_Map_9	VLAN mapping table registers 9	1C _H	61
VLAN_Map_10	VLAN mapping table registers 10	1D _H	61
VLAN_Map_11	VLAN mapping table registers 11	1E _H	61
VLAN_Map_12	VLAN mapping table registers 12	1F _H	61
VLAN_Map_13	VLAN mapping table registers 13	20 _H	61
VLAN_Map_14	VLAN mapping table registers 14	21 _H	61
VLAN_Map_15	VLAN mapping table registers 15	22 _H	61
ResReg_7	Reserved Register 7	23 _H	61
ResReg_8	Reserved Register 8	24 _H	62

Table 31 Registers Overview (cont'd)

Register Short Name	Register Long Name	Offset Address	Page Number
ResReg_9	Reserved Register 9	25 _H	62
ResReg_10	Reserved Register 10	26 _H	62
ResReg_11	Reserved Register 11	27 _H	62
ConfigReg_4	Configuration Register 4	28 _H	62
ConfigReg_5	Configuration Register 5	29 _H	62
ConfigReg_6	Configuration Register 6	2A _H	63
ConfigReg_7	Configuration Register 7	2B _H	63
ConfigReg_8	Configuration Register	2C _H	64
ResReg_12	Reserved Register 12	2D _H	65
ResReg_13	Reserved Register 13	2E _H	65
PH_Restart	PHY Restart	2F _H	65
ConfigReg_	Miscellaneous Configuration Register 9	30 _H	66
BWCon_0	Bandwidth Control Register 0	31 _H	66
BWCon_1	Bandwidth Control Register 1	32 _H	67
BWConEn	Bandwidth Control Enable Register	33 _H	68
Serial Register			
ChipID	Chip Identifier Register	00 _H	71
PortStat_0	Port Status Register 0	01 _H	71
PortStat_1	Port Status Register 1	02 _H	73
CabStat	Cable Broken Status	03 _H	74
P0_RP_CNT	Port 0 Receive Packet Count	04 _H	75
P1_RP_CNT	Port 1 Receive Packet Count	06 _H	75
P2_RP_CNT	Port 2 Receive Packet Count	08 _H	75
P3_RP_CNT	Port 3 Receive Packet Count	0A _H	75
P4_RP_CNT	Port 4 Receive Packet Count	0B _H	75
P5_RP_CNT	Port 5 Receive Packet Count	0C _H	75
P0_RB_CNT	Port 0 Receive Byte Count	0D _H	75
P1_RB_CNT	Port 1 Receive Byte Count	0F _H	75
P2_RB_CNT	Port 2 Receive Byte Count	11 _H	75
P3_RB_CNT	Port 3 Receive Byte Count	13 _H	75
P4_RB_CNT	Port 4 Receive Byte Count	14 _H	75
P5_RB_CNT	Port 5 Receive Byte Count	15 _H	75
P0_TP_CNT	Port 0 Transmit Packet Count	16 _H	75
P1_TP_CNT	Port 1 Transmit Packet Count	18 _H	75
P2_TP_CNT	Port 2 Transmit Packet Count	1A _H	75
P3_TP_CNT	Port 3 Transmit Packet Count	1C _H	75
P4_TP_CNT	Port 4 Transmit Packet Count	1D _H	75
P5_TP_CNT	Port 5 Transmit Packet Count	1E _H	75
P0_TB_CNT	Port 0 Transmit Byte Count	1F _H	76
P1_TB_CNT	Port 1 Transmit Byte Count	21 _H	76
P2_TB_CNT	Port 2 Transmit Byte Count	23 _H	76

Table 31 Registers Overview (cont'd)

Register Short Name	Register Long Name	Offset Address	Page Number
P3_TB_CNT	Port 3 Transmit Byte Count	25 _H	76
P4_TB_CNT	Port 4 Transmit Byte Count	26 _H	76
P5_TB_CNT	Port 5 Transmit Byte Count	27 _H	76
P0_COL_CNT	Port 0 Collision Count	28 _H	76
P1_COL_CNT	Port 1 Collision Count	2A _H	76
P2_COL_CNT	Port 2 Collision Count	2C _H	76
P3_COL_CNT	Port 3 Collision Count	2E _H	76
P4_COL_CNT	Port 4 Collision Count	2F _H	76
P5_COL_CNT	Port 5 Collision Count	30 _H	76
P0_ERR_CNT	Port 0 Error Count	31 _H	76
P1_ERR_CNT	Port 1 Error Count	33 _H	76
P2_ERR_CNT	Port 2 Error Count	35 _H	76
P3_ERR_CNT	Port 3 Error Count	37 _H	76
P4_ERR_CNT	Port 4 Error Count	38 _H	76
P5_ERR_CNT	Port 5 Error Count	39 _H	76
OverFlow_0	Over Flow Flag Register 0	3A _H	76
OverFlow_1	Over Flow Flag Register 1	3B _H	77
OverFlow_2	Over Flow Flag Register 2	3C _H	78

5 16 Bits Mode Registers Description

Broadcast Storm

ADM6996FC/FCX/FHX allows users to limit the traffic of the broadcast address (DA = FFFFFFFF_H) to prevent them from blocking the switch bandwidth. If users also want to limit the multicast packets (DA[40] = 1_B), they can set the Multicast Packet Counted to Storming Counter (see 0010_H, **MP**) function. Two threshold and storm enable bits (see 003B_H and 003C_H, **STORM_EN**, **STORM_100_TH**, **STORM_10_TH**) are used to control the broadcast storm. The threshold is described in **Table 32 Broadcast Storming Threshold**.

1. Time Scale. ADM6996FC/FCX/FHX uses 50ms as the scale to meter the storm packets.
2. Storm keeps on at least 1.6 seconds if any of the ports meet the rising threshold in the 4 consecutive 50 ms intervals. In these 1.6 seconds, the ports meet the rising threshold and will start to discard the broadcast or multicast packets until the 50 ms interval expires. Users could also disable Input Filter (see 000B_H, **IF**) function to forward above packets to the un-congested port instead of discarding directly.
3. Storm finishes. After the 1.6-second storm period, ADM6996FC/FCX/FHX will check the port that makes the storm on. If all of these ports meet the falling threshold in the 2 consecutive 50 ms intervals and no other ports meet the rising threshold at the same time, ADM6996FC/FCX/FHX will treat it the storm has finished.

Priority Queue

ADM6996FC/FCX/FHX supports 4 priority queues and each is assigned a weight.

The EEPROM provides ADM6996FC/FCX/FHX with many option settings

Main Settings

- Port Configuration: Speed, Duplex, Flow Control Capability and Tag/ Untag.
- VLAN & TOS Priority Mapping
- Broadcast Storming rate and Trunk.
- Fiber Select, Auto MDIX select
- VLAN Mapping
- Per Port Buffer number
- Priority queue and smart discard ratio

Table 32 Broadcast Storming Threshold

Parameter	Rising Threshold	Falling Threshold
All link ports are 100M	100M Threshold (See 003B _H)	1/2 100M Threshold
Not All link ports are 100M	10M Threshold (See 003C _H)	1/2 10M Threshold

Table 33 Priority Queue Weight Ratio

Queue	Weight
Queue 0	Weight = 1
Queue 1	Weight = 2
Queue 2	Weight = 4
Queue 3	Weight = 8

Table 34 Registers Address Space

Module	Base Address	End Address	Note
EEPROM Basic Register Map	0000 _H	003F _H	
EEPROM Extended Register Map	0040 _H	009C _H	
Counter and Switch Status Map	00A0 _H	0143 _H	
PHY Register Map	0200 _H	02FF _H	

Table 35 Registers Overview

Register Short Name	Register Long Name	Offset Address	Page Number
SIG	Signature Register	00 _H	97
P0BC	P0 Basic Control Register	01 _H	97
Res0	Reserved Register 0	02 _H	99
P1	Basic Control Register 1	03 _H	98
Res1	Reserved Register 1	04 _H	99
P2	Basic Control Register 2	05 _H	98
Res2	Reserved Register 2	06 _H	99
P3	Basic Control Register 3	07 _H	98
P4	Basic Control Register 4	08 _H	99
P5	Basic Control Register 5	09 _H	99
SC0	System Control Register 0	0A _H	100
SC1	System Control Register 1	0B _H	101
Res3	Reserved Register 3	0C _H	99
Res4	Reserved Register 4	0D _H	99
VPM	VLAN Priority Map Register	0E _H	102
TPM	TOS Priority Map Register	0F _H	103
SC2	System Control Register 2	10 _H	104
SC3	System Control Register 3	11 _H	105
SC4	System Control Register 4	12 _H	106
P0SO	Port 0 Security Option	13 _H	107
P1SO	Port 1 Security Option	14 _H	108
P2SO	Port 2 Security Option	15 _H	108
P3SO	Port 3 Security Option	16 _H	108
P4SO	Port 4 Security Option	17 _H	108
P5SO	Port 5 Security Option	18 _H	108
UFGPM	Unicast Port Map and Forward Group Port Map	19 _H	108
BFGPM	Broadcast Port Map and Forward Group Port Map	1A _H	109
MFGPM	Multicast Port Map and Forward Group Port Map	1B _H	110
RFGPM	Reserve Port Map and Forward Group Port Map	1C _H	111
PIOFGPM	Packet Identification Option, Forward Group Port Map	1D _H	112

16 Bits Mode Registers Description

Table 35 Registers Overview (cont'd)

Register Short Name	Register Long Name	Offset Address	Page Number
VPEFGPM	VLAN Priority Enable and Forward Group Port Map	1E _H	112
SPEFGPM	Service Priority Enable and Forward Group Port Map	1F _H	113
IFNTFGPM	Input Force No Tag and Forward Group Port Map	20 _H	114
IFFGPM	Ingress Filter and Forward Group Port Map	21 _H	115
VSDFGPM	VLAN Security Disable and Forward Group Port Map	22 _H	116
Res5	Reserved Register 5	23 _H	99
Res6	Reserved Register 6	24 _H	99
IMEIJT	IGMP/MLDTRAP Enable and Input Jam Threshold Register	25 _H	117
Q2WVECPO	Queue 2 Weight, VID Exist Check, and PPPOE Port Only	26 _H	117
Q3WBPVAO	Queue 3 Weight, Back to Port VLAN, and Admit Only VLAN-Tagged	27 _H	117
IDTEP	Input Double Tag Enable, and P0VID[11:4]	28 _H	118
ODTEP	Output Double Tag Enable, and P1VID[11:4]	29 _H	118
OTBP	Output Tag Bypass, and P2VID[11:4]	2A _H	119
P11_4	P3VID[11:4], and P4VID[11:4]	2B _H	119
RACP	Reserved Address Control, and P5VID[11:4]	2C _H	120
PHYC	PHY Control Register	2D _H	120
Res7	Reserved Register 7	2E _H	99
PR	PHY Restart Register	2F _H	120
MISC	Miscellaneous Register	30 _H	121
BBC0	Basic Bandwidth Control Register 0	31 _H	122
BBC1	Basic Bandwidth Control Register 1	32 _H	122
BCE	Bandwidth Control Enable Register	33 _H	123
EBC0	Extended Bandwidth Control Register 0	34 _H	125
EBC1	Extended Bandwidth Control Register 1	35 _H	126
EBC2	Extended Bandwidth Control Register 2	36 _H	126
EBC3	Extended Bandwidth Control Register 3	37 _H	126
EBC4	Extended Bandwidth Control Register 4	38 _H	127
EBC5	Extended Bandwidth Control Register 5	39 _H	128
DVMEBC6	Default VLAN Member and Extended Bandwidth Control Register 6	3A _H	128
NS0	New Storm Register 0	3B _H	129
NS1	New Storm Register 1	3C _H	129
NRAC0	New Reserve Address Control Register 0	3D _H	130
NRAC1	New Reserve Address Control Register 1	3E _H	130
Res8	Reserved Register 8	3F _H	99
VF0L	VLAN Filter 0 Low	40 _H	131

16 Bits Mode Registers Description

Table 35 Registers Overview (cont'd)

Register Short Name	Register Long Name	Offset Address	Page Number
VF0H	VLAN Filter 0 High	41 _H	132
VF1L	VLAN Filter 1 Low	42 _H	131
VF1H	VLAN Filter 1 High	43 _H	132
VF2L	VLAN Filter 2 Low	44 _H	131
VF2H	VLAN Filter 2 High	45 _H	132
VF3L	VLAN Filter 3Low	46 _H	131
VF3H	VLAN Filter 3 High	47 _H	132
VF4L	VLAN Filter 4 Low	48 _H	131
VF4H	VLAN Filter 4 High	49 _H	133
VF5L	VLAN Filter 5 Low	4A _H	132
VF5H	VLAN Filter 5 High	4B _H	133
VF6L	VLAN Filter 6 Low	4C _H	132
VF6H	VLAN Filter 6 High	4D _H	133
VF7L	VLAN Filter 7 Low	4E _H	132
VF7H	VLAN Filter 7 High	4F _H	133
VF8L	VLAN Filter 8 Low	50 _H	132
VF8H	VLAN Filter 8 High	51 _H	133
VF9L	VLAN Filter 9 Low	52 _H	132
VF9H	VLAN Filter 9 High	53 _H	133
VF10L	VLAN Filter 10 Low	54 _H	132
VF10H	VLAN Filter 10 High	55 _H	133
VF11L	VLAN Filter 11 Low	56 _H	132
VF11H	VLAN Filter 11 High	57 _H	133
VF12L	VLAN Filter 12 Low	58 _H	132
VF12H	VLAN Filter 12 High	59 _H	133
VF13L	VLAN Filter 13 Low	5A _H	132
VF13H	VLAN Filter 13 High	5B _H	133
VF14L	VLAN Filter 14 Low	5C _H	132
VF14H	VLAN Filter 14 High	5D _H	133
VF15L	VLAN Filter 15 Low	5E _H	132
VF15H	VLAN Filter 15 High	5F _H	133
TF0	Type Filter 0	60 _H	133
TF1	Type Filter 1	61 _H	133
TF2	Type Filter 2	62 _H	133
TF3	Type Filter 3	63 _H	133
TF4	Type Filter 4	64 _H	133
TF5	Type Filter 5	65 _H	133
TF6	Type Filter 6	66 _H	133
TF7	Type Filter 7	67 _H	133
PF_1_0	Protocol Filter 1 and 0	68 _H	134
PF_3_2	Protocol Filter 3 and 2	68 _H	134

16 Bits Mode Registers Description

Table 35 Registers Overview (cont'd)

Register Short Name	Register Long Name	Offset Address	Page Number
PF_5_4	Protocol Filter 5 and 4	69 _H	134
PF_7_6	Protocol Filter 7 and 6	6A _H	134
Res9	Reserved Register 9	6C _H	99
Res10	Reserved Register 10	6D _H	99
Res11	Reserved Register 11	6E _H	99
Res12	Reserved Register 12	6F _H	99
Res13	Reserved Register 13	70 _H	99
Res14	Reserved Register 14	71 _H	99
Res15	Reserved Register 15	72 _H	99
Res16	Reserved Register 16	73 _H	99
Res17	Reserved Register 17	74 _H	99
Res18	Reserved Register 18	75 _H	99
Res19	Reserved Register 19	76 _H	99
Res20	Reserved Register 20	77 _H	99
Res21	Reserved Register 21	78 _H	100
Res22	Reserved Register 22	79 _H	100
Res23	Reserved Register 23	7A _H	100
Res24	Reserved Register 24	7B _H	100
Res25	Reserved Register 25	7C _H	100
Res26	Reserved Register 26	7D _H	100
Res27	Reserved Register 27	7E _H	100
Res28	Reserved Register 28	7F _H	100
Res29	Reserved Register 29	80 _H	100
Res30	Reserved Register 30	81 _H	100
Res31	Reserved Register 31	82 _H	100
Res32	Reserved Register 32	83 _H	100
Res33	Reserved Register 33	84 _H	100
Res34	Reserved Register 34	85 _H	100
Res35	Reserved Register 35	86 _H	100
Res36	Reserved Register 36	87 _H	100
Res37	Reserved Register 37	88 _H	100
Res38	Reserved Register 38	89 _H	100
Res39	Reserved Register 39	8A _H	100
Res40	Reserved Register 40	8B _H	100
TUF0	TCP/UDP Filter 0	8C _H	134
TUF1	TCP/UDP Filter 1	8D _H	135
TUF2	TCP/UDP Filter 2	8E _H	135
TUF3	TCP/UDP Filter 3	8F _H	135
TUF4	TCP/UDP Filter 4	90 _H	135
TUF5	TCP/UDP Filter 5	91 _H	135
TUF6	TCP/UDP Filter 6	92 _H	135

16 Bits Mode Registers Description

Table 35 Registers Overview (cont'd)

Register Short Name	Register Long Name	Offset Address	Page Number
TUF7	TCP/UDP Filter 7	93 _H	135
TFA	Type Filter Action	94 _H	135
PFA	Protocol Filter Action	95 _H	136
TUA0	TCP/UDP Action 0	96 _H	137
TUA1	TCP/UDP Action 1	97 _H	137
TUA2	TCP/UDP Action 2	98 _H	138
Res41	Reserved Register 41	99 _H	100
IE	Interrupt Enable Register	9A _H	139
IS	Interrupt Status Register	9B _H	140
Res42	Reserved Register 42	9C _H	100
CI0	Chip Identifier 0	A0 _H	141
CI1	Chip Identifier 1	A1 _H	141
PS0	Port Status 0	A2 _H	141
PS1	Port Status 1	A3 _H	142
PS2	Port Status 2	A4 _H	143
Res43	Reserved Register 43	A5 _H	100
Res44	Reserved Register 44	A6 _H	100
Res45	Reserved Register 45	A7 _H	100
CL0	Port 0 Receive Packet Counter Low	A8 _H	144
CH0	Port 0 Receive Packet Counter High	A9 _H	145
CL1	Port 1 Receive Packet Counter Low	AC _H	144
CH1	Port 1 Receive Packet Counter High	AD _H	146
CL2	Port 2 Receive Packet Counter Low	B0 _H	144
CH2	Port 2 Receive Packet Counter High	B1 _H	146
CL3	Port 3 Receive Packet Counter Low	B4 _H	144
CH3	Port 3 Receive Packet Counter High	B5 _H	146
CL4	Port 4 Receive Packet Counter Low	B6 _H	144
CH4	Port 4 Receive Packet Counter High	B7 _H	146
CL5	Port 5 Receive Packet Counter Low	B8 _H	144
CH5	Port 5 Receive Packet Counter High	B9 _H	146
CL6	Port 0 Receive Packet Byte Count Low	BA _H	144
CH6	Port 0 Receive Packet Byte Count High	BB _H	146
CL7	Port 1 Receive Packet Byte Count Low	BE _H	144
CH7	Port 1 Receive Packet Byte Count High	BF _H	146
CL8	Port 2 Receive Packet Byte Count Low	C2 _H	145
CH8	Port 2 Receive Packet Byte Count High	C3 _H	146
CL9	Port 3 Receive Packet Byte Count Low	C6 _H	145
CH9	Port 3 Receive Packet Byte Count High	C7 _H	146
CL10	Port 4 Receive Packet Byte Count Low	C8 _H	145
CH10	Port 4 Receive Packet Byte Count High	C9 _H	146
CL11	Port 5 Receive Packet Byte Count Low	CA _H	145

16 Bits Mode Registers Description

Table 35 Registers Overview (cont'd)

Register Short Name	Register Long Name	Offset Address	Page Number
CH11	Port 5 Receive Packet Byte Count High	CB _H	146
CL12	Port 0 Transmit Packet Count Low	CC _H	145
CH12	Port 0 Transmit Packet Count High	CD _H	146
CL13	Port 1 Transmit Packet Count Low	D0 _H	145
CH13	Port 1 Transmit Packet Count High	D1 _H	146
CL14	Port 2 Transmit Packet Count Low	D4 _H	145
CH14	Port 2 Transmit Packet Count High	D5 _H	146
CL15	Port 3 Transmit Packet Count Low	D8 _H	145
CH15	Port 3 Transmit Packet Count High	D9 _H	146
CL16	Port 4 Transmit Packet Count Low	DA _H	145
CH16	Port 4 Transmit Packet Count High	DB _H	146
CL17	Port 5 Transmit Packet Count Low	DC _H	145
CH17	Port 5 Transmit Packet Count High	DD _H	146
CL18	Port 0 Transmit Packet Byte Count Low	DE _H	145
CH18	Port 0 Transmit Packet Byte Count High	DF _H	146
CL19	Port 1 Transmit Packet Byte Count Low	E2 _H	145
CH19	Port 1 Transmit Packet Byte Count High	E3 _H	146
CL20	Port 2 Transmit Packet Byte Count Low	E6 _H	145
CH20	Port 2 Transmit Packet Byte Count High	E7 _H	146
CL21	Port 3 Transmit Packet Byte Count Low	EA _H	145
CH21	Port 3 Transmit Packet Byte Count High	EB _H	146
CL22	Port 4 Transmit Packet Byte Count Low	EC _H	145
CH22	Port 4 Transmit Packet Byte Count High	ED _H	146
CL23	Port 5 Transmit Packet Byte Count Low	EE _H	145
CH23	Port 5 Transmit Packet Byte Count High	EF _H	146
CL24	Port 0 Collision Count Low	F0 _H	145
CH24	Port 0 Collision Count High	F1 _H	146
CL25	Port 1 Collision Count Low	F4 _H	145
CH25	Port 1 Collision Count High	F5 _H	146
CL26	Port 2 Collision Count Low	F8 _H	145
CH26	Port 2 Collision Count High	F9 _H	146
CL27	Port 3 Collision Count Low	FC _H	145
CH27	Port 3 Collision Count High	FD _H	146
CL28	Port 4 Collision Count Low	FE _H	145
CH28	Port 4 Collision Count High	FF _H	146
CL29	Port 5 Collision Count Low	100 _H	145
CH29	Port 5 Collision Count High	101 _H	146
CL30	Port 0 Error Count Low	102 _H	145
CH30	Port 0 Error Count High	103 _H	146
CL31	Port 1 Error Count Low	106 _H	145
CH31	Port 1 Error Count High	107 _H	146

16 Bits Mode Registers Description

Table 35 Registers Overview (cont'd)

Register Short Name	Register Long Name	Offset Address	Page Number
CL32	Port 2 Error Count Low	10A _H	145
CH32	Port 2 Error Count High	10B _H	146
CL33	Port 3 Error Count Low	10E _H	145
CH33	Port 3 Error Count High	10F _H	146
CL34	Port 4 Error Count Low	110 _H	145
CH34	Port 4 Error Count High	111 _H	147
CL35	Port 5 Error Count Low	112 _H	145
CH35	Port 5 Error Count High	113 _H	147
OFF0	Over-Flow Flag 0	114 _H	147
OFF1	Over-Flow Flag 1	115 _H	148
OFF2	Over-Flow Flag 2	116 _H	148
OFF3	Over-Flow Flag 3	117 _H	149
OFF4	Over-Flow Flag 4	118 _H	150
OFF5	Over-Flow Flag 5	119 _H	151
HSL	Hardware Setting Low Register	130 _H	151
HSH	Hardware Setting High Register	131 _H	152
Res46	Reserved Register 46	132 _H	100
Res47	Reserved Register 47	133 _H	100
Res48	Reserved Register 48	134 _H	100
AO	Assign Option Register	135 _H	153
Res49	Reserved Register 49	136 _H	100
Res50	Reserved Register 50	137 _H	100
SVP	Security Violation Port	138 _H	153
SS0	Security Status 0	139 _H	154
SS1	Security Status 1	13A _H	154
FLAS	First Lock Address Search	13B _H	155
FLA1	First Lock Address [15:0]	13C _H	155
FLA2	First Lock Address [31:16]	13D _H	156
FLA3	First Lock Address [47:32]	13E _H	156
FLF	First Lock FID	13F _H	156
CCL	Counter Control Low Register	140 _H	157
Res51	Reserved Register 51	141 _H	100
CSL	Counter Status Low Register	142 _H	157
CSH	Counter Status High Register	143 _H	157
PHY_C0	PHY Control Register of Port 0	200 _H	158
PHY_S0	PHY Status Register of Port 0	201 _H	160
PHY_I0_A	PHY Identifier Register of Port 0 (A)	202 _H	162
PHY_I0_B	PHY Identifier Register of Port 0 (B)	203 _H	162
ANAP0	Auto Negotiation Advertisement Register of Port 0	204 _H	163
ANLPA0	Auto Negotiation Link Partner Ability Register of Port 0	205 _H	164

16 Bits Mode Registers Description

Table 35 Registers Overview (cont'd)

Register Short Name	Register Long Name	Offset Address	Page Number
ANE0	Auto Negotiation Expansion Register of Port 0	206 _H	166
NPT0	Next Page Transmit Register of Port 0	207 _H	166
LPNP0	Link Partner Next Page Register of Port 0	208 _H	167
PHY_C1	PHY Control Register of Port 1	220 _H	160
PHY_S1	PHY Status Register of Port 1	221 _H	162
PHY_I1_A	PHY Identifier Register of Port 1 (A)	222 _H	162
PHY_I1_B	PHY Identifier Register of Port 1 (B)	223 _H	163
ANAP1	Auto Negotiation Advertisement Register of Port 1	224 _H	164
ANLPA1	Auto Negotiation Link Partner Ability Register of Port 1	225 _H	165
ANE1	Auto Negotiation Expansion Register of Port 1	226 _H	166
NPT1	Next Page Transmit Register of Port 1	227 _H	167
LPNP1	Link Partner Next Page Register of Port 1	228 _H	168
PHY_C2	PHY Control Register of Port 2	240 _H	160
PHY_S2	PHY Status Register of Port 2	241 _H	162
PHY_I2_A	PHY Identifier Register of Port 2 (A)	242 _H	162
PHY_I2_B	PHY Identifier Register of Port 2 (B)	243 _H	163
ANAP2	Auto Negotiation Advertisement Register of Port 2	244 _H	164
ANLPA2	Auto Negotiation Link Partner Ability Register of Port 2	245 _H	165
ANE2	Auto Negotiation Expansion Register of Port 2	246 _H	166
NPT2	Next Page Transmit Register of Port 2	247 _H	167
LPNP2	Link Partner Next Page Register of Port 2	248 _H	168
PHY_C3	PHY Control Register of Port 3	260 _H	160
PHY_S3	PHY Status Register of Port 3	261 _H	162
PHY_I3_A	PHY Identifier Register of Port 3 (A)	262 _H	162
PHY_I3_B	PHY Identifier Register of Port 3 (B)	263 _H	163
ANAP3	Auto Negotiation Advertisement Register of Port 3	264 _H	164
ANLPA3	Auto Negotiation Link Partner Ability Register of Port 3	265 _H	165
ANE3	Auto Negotiation Expansion Register of Port 3	266 _H	166
NPT3	Next Page Transmit Register of Port 3	267 _H	167
LPNP3	Link Partner Next Page Register of Port 3	268 _H	168
PHY_C4	PHY Control Register of Port 4	280 _H	160
PHY_S4	PHY Status Register of Port 4	281 _H	162
PHY_I4_A	PHY Identifier Register of Port 4 (A)	282 _H	162
PHY_I4_B	PHY Identifier Register of Port 4 (B)	283 _H	163
ANAP4	Auto Negotiation Advertisement Register of Port 4	284 _H	164
ANLPA4	Auto Negotiation Link Partner Ability Register of Port 4	285 _H	165
ANE4	Auto Negotiation Expansion Register of Port 4	286 _H	166

16 Bits Mode Registers Description

Table 35 Registers Overview (cont'd)

Register Short Name	Register Long Name	Offset Address	Page Number
NPT4	Next Page Transmit Register of Port 4	287 _H	167
LPNP4	Link Partner Next Page Register of Port 4	288 _H	168

The register is addressed wordwise.

Table 36 Register Access Types

Mode	Symbol	Description HW	Description SW
read/write	rw	Register is used as input for the HW	Register is read and writable by SW
read	r	Register is written by HW (register between input and output -> one cycle delay)	Value written by software is ignored by hardware; that is, software may write any value to this field without affecting hardware behavior (= Target for development.)
Read only	ro	Register is set by HW (register between input and output -> one cycle delay)	SW can only read this register
Read virtual	rv	Physically, there is no new register, the input of the signal is connected directly to the address multiplexer.	SW can only read this register
Latch high, self clearing	lhsc	Latch high signal at high level, clear on read	SW can read the register
Latch low, self clearing	llsc	Latch high signal at low-level, clear on read	SW can read the register
Latch high, mask clearing	lhmk	Latch high signal at high level, register cleared with written mask	SW can read the register, with write mask the register can be cleared (1 clears)
Latch low, mask clearing	llmk	Latch high signal at low-level, register cleared on read	SW can read the register, with write mask the register can be cleared (1 clears)
Interrupt high, self clearing	ihsc	Differentiate the input signal (low->high) register cleared on read	SW can read the register
Interrupt low, self clearing	ilsc	Differentiate the input signal (high->low) register cleared on read	SW can read the register
Interrupt high, mask clearing	ihmk	Differentiate the input signal (high->low) register cleared with written mask	SW can read the register, with write mask the register can be cleared
Interrupt low, mask clearing	ilmk	Differentiate the input signal (low->high) register cleared with written mask	SW can read the register, with write mask the register can be cleared
Interrupt enable register	ien	Enables the interrupt source for interrupt generation	SW can read and write this register
latch_on_reset	lor	rw register, value is latched after first clock cycle after reset	Register is read and writable by SW
Read/write self clearing	rwsc	Register is used as input for the hw, the register will be cleared due to a HW mechanism.	Writing to the register generates a strobe signal for the HW (1 pdi clock cycle) Register is read and writable by SW.

Table 37 Registers Clock Domains

Clock Short Name	Description
-	-

5.1 EEPROM Basic Registers

Signature Register

SIG	Offset	Reset Value
Signature Register	00 _H	4154 _H

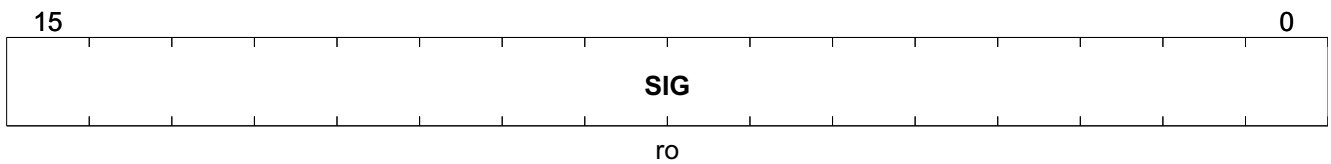

Field	Bits	Type	Description
SIG	15:0	ro	Signature The value must be 4154 _H . ADM6996FC/FCX/FHX uses this value to check if the EEPROM is attached. If the value in the EEPROM does not equal to 4154 _H , ADM6996FC/FCX/FHX will stop loading the EEPROM even if the EEPROM is attached. ADM6996FC/FCX/FHX will use the default value to initialize.

P0 Basic Control Register

P0BC	Offset	Reset Value
P0 Basic Control Register	01 _H	040F _H

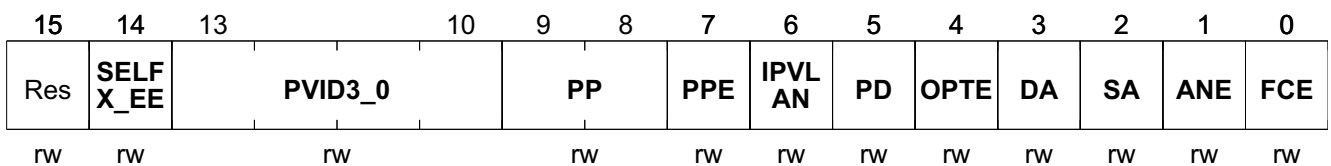

Field	Bits	Type	Description
Res	15	rw	Reserved
SELF_X_EE	14	rw	Select FX This bit is used together with the value (p4fx_hw) on the pin P4FX during the power on reset to decide if the PHY operates on the fiber mode. This bit is useless in Port 5. Port 0, 1, 2, 3: selfx_ee Description Port 4: {p4fx_hw, selfx_ee} Description 1x _B Port 4: Port 4 will operate in the fiber mode 00 _B Port 4: Port 4 will operate in the twisted mode 01 _B Port 4: Port 4 will operate in the fiber mode

16 Bits Mode Registers Description

Field	Bits	Type	Description
PVID3_0	13:10	rw	Private VID See 0028 _H ~ 002C _H to find the other PVID [11:4]
PP	9:8	rw	Port Priority 00 _B Assign packets to Queue 0 01 _B Assign packets to Queue 1 10 _B Assign packets to Queue 2 11 _B Assign packets to Queue 3
PPE	7	rw	Port Priority Enable 0 _B The port priority is disabled 1 _B The port priority is enabled
IPVLAN	6	rw	IP over VLAN PRI 0 _B Use the priority bits in the tag header to assign the priority queue 1 _B Use the IP PRI to assign the priority queue
PD	5	rw	Port Disable 0 _B Port 0, 1, 2, 3, 4: PHY work s normally. Port 5: Port 5 works normally 1 _B Port 0, 1, 2, 3, 4. PHY is disabled. Port 5: Port 5 is forced to link down
OPTE	4	rw	Output Packet Tagging Enable 0 _B Untagged packets are transmitted 1 _B Tagged packets are transmitted
DA	3	rw	Duplex Ability It is useless in Port 5. 0 _B Recommend PHY to work in the half duplex mode 1 _B Recommend PHY to work in the full duplex mode
SA	2	rw	Speed Ability 0 _B Recommend PHY to work in the 10M mode 1 _B Recommend PHY to work in the 100M mode
ANE	1	rw	Auto Negotiation Enable 0 _B Recommend PHY to work without Auto Negotiation 1 _B Recommend PHY to work with Auto Negotiation, when the value on the pin DUPCOL0 during the power on reset is 1
FCE	0	rw	Flow Control Enable 0 _B Recommend MAC to work without Pause or Back Pressure 1 _B In full duplex, recommend MAC to work with Pause when the value on the TXD0 during the power on reset is 1. In half duplex, recommend MAC to work with Back Pressure when the value on the DUPCOL2 during the power on reset is 1

Similar Registers

Table 38 Basic Control Registers 1 to 5

Register Short Name	Register Long Name	Offset Address	Page Number
P1	Basic Control Register 1	03 _H	
P2	Basic Control Register 2	05 _H	
P3	Basic Control Register 3	07 _H	

16 Bits Mode Registers Description

Table 38 Basic Control Registers 1 to 5 (cont'd)

Register Short Name	Register Long Name	Offset Address	Page Number
P4	Basic Control Register 4	08 _H	
P5	Basic Control Register 5	09 _H	

Reserved Register 0

Res0	Offset	Reset Value
Reserved Register 0	02 _H	0000 _H

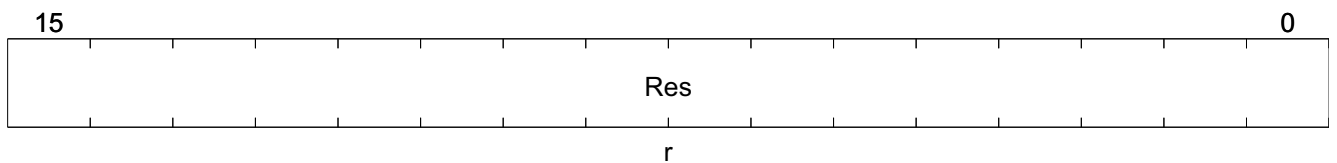

Field	Bits	Type	Description
Res	15:0	r	Reserved

Similar Registers

Table 39 Reserved Registers

Register Short Name	Register Long Name	Offset Address	Page Number
Res1	Reserved Register 1	04 _H	
Res2	Reserved Register 2	06 _H	
Res3	Reserved Register 3	0C _H	
Res4	Reserved Register 4	0D _H	
Res5	Reserved Register 5	23 _H	
Res6	Reserved Register 6	24 _H	
Res7	Reserved Register 7	2E _H	
Res8	Reserved Register 8	3F _H	
Res9	Reserved Register 9	6C _H	
Res10	Reserved Register 10	6D _H	
Res11	Reserved Register 11	6E _H	
Res12	Reserved Register 12	6F _H	
Res13	Reserved Register 13	70 _H	
Res14	Reserved Register 14	71 _H	
Res15	Reserved Register 15	72 _H	
Res16	Reserved Register 16	73 _H	
Res17	Reserved Register 17	74 _H	
Res18	Reserved Register 18	75 _H	
Res19	Reserved Register 19	76 _H	
Res20	Reserved Register 20	77 _H	

Table 39 Reserved Registers (cont'd)

Register Short Name	Register Long Name	Offset Address	Page Number
Res21	Reserved Register 21	78 _H	
Res22	Reserved Register 22	79 _H	
Res23	Reserved Register 23	7A _H	
Res24	Reserved Register 24	7B _H	
Res25	Reserved Register 25	7C _H	
Res26	Reserved Register 26	7D _H	
Res27	Reserved Register 27	7E _H	
Res28	Reserved Register 28	7F _H	
Res29	Reserved Register 29	80 _H	
Res30	Reserved Register 30	81 _H	
Res31	Reserved Register 31	82 _H	
Res32	Reserved Register 32	83 _H	
Res33	Reserved Register 33	84 _H	
Res34	Reserved Register 34	85 _H	
Res35	Reserved Register 35	86 _H	
Res36	Reserved Register 36	87 _H	
Res37	Reserved Register 37	88 _H	
Res38	Reserved Register 38	89 _H	
Res39	Reserved Register 39	8A _H	
Res40	Reserved Register 40	8B _H	
Res41	Reserved Register 41	99 _H	
Res42	Reserved Register 42	9C _H	
Res43	Reserved Register 43	A5 _H	
Res44	Reserved Register 44	A6 _H	
Res45	Reserved Register 45	A7 _H	
Res46	Reserved Register 46	132 _H	
Res47	Reserved Register 47	133 _H	
Res48	Reserved Register 48	134 _H	
Res49	Reserved Register 49	136 _H	
Res50	Reserved Register 50	137 _H	
Res51	Reserved Register 51	141 _H	

System Control Register 0

SC0	Offset	Reset Value
System Control Register 0	0A_H	5802_H

16 Bits Mode Registers Description

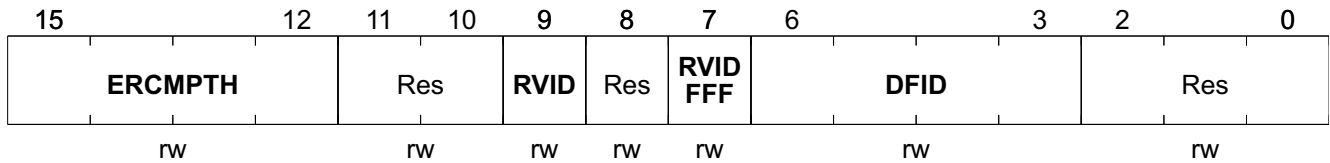

Field	Bits	Type	Description
ERCMPTH	15:12	rw	Earlier Cycles for Transmission It means the earlier cycles for transmission used in ADM6996FC/FCX/FHX. It is for the engineer debug purpose.
Res	11:10	rw	Reserved
RVID	9	rw	Replace VID0 and VID1 0 _B Do not replace 1 _B Replace
Res	8	rw	Reserved
RVIDFFF	7	rw	Replace VIDFFF Always Drop
DFID	6:3	rw	Default FID Always 0000 _B
Res	2:0	rw	Reserved

System Control Register 1

SC1	Offset	Reset Value
System Control Register 1	0B_H	8001_H

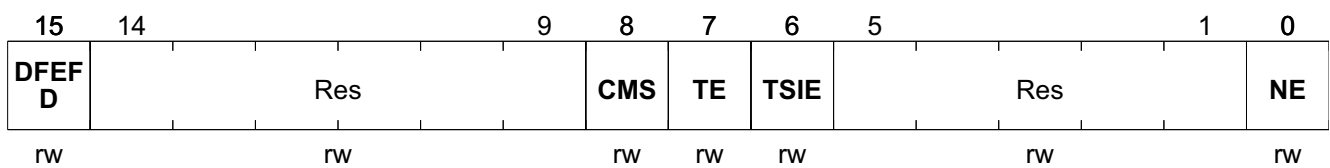

Field	Bits	Type	Description
DFEFD	15	rw	Disable Far-End-Fault Detection 0 _B Far-End-Fault detection is enabled 1 _B Far-End-Fault detection is disabled
Res	14:9	rw	Reserved
CMS	8	rw	Carrier Mask Select 0 _B Mask CRS of 4 Cycles 1 _B Mask CRS of 5 Cycles
TE	7	rw	Port 3 and Port 4 Trunk Enable 0 _B No trunk is enabled 1 _B Port 3 and Port 4 are trunked

16 Bits Mode Registers Description

Field	Bits	Type	Description
TSIE	6	rw	Transmit Short IPG Enable 0 _B 96 bits time is used 1 _B 88/96 bits time is used
Res	5:1	rw	Reserved
NE	0	rw	New EEPROM 0 _B Use old EEPROM functions 1 _B New EEPROM function is enabled

VLAN Priority Map Register

VPM **Offset**
VLAN Priority Map Register **0E_H** **Reset Value**
FA50_H

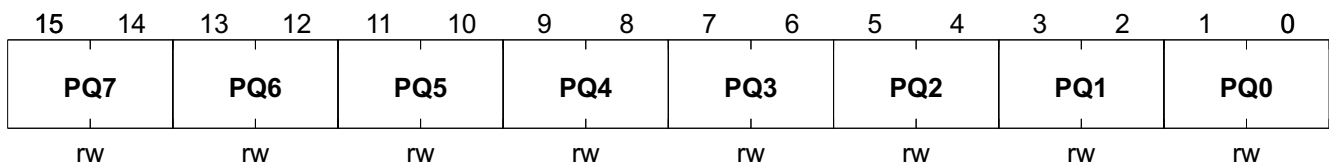

Field	Bits	Type	Description
PQ7	15:14	rw	Priority Queue 7 These 2 bits are used as the priority queue when the tagged packets with the user priority = 111 _B are received on the port. 00 _B Queue 0 01 _B Queue 1 10 _B Queue 2 11 _B Queue 3
PQ6	13:12	rw	Priority Queue 6 These 2 bits are used as the priority queue when the tagged packets with the user priority = 110 _B are received on the port.
PQ5	11:10	rw	Priority Queue 5 These 2 bits are used as the priority queue when the tagged packets with the user priority = 101 _B are received on the port.
PQ4	9:8	rw	Priority Queue 4 These 2 bits are used as the priority queue when the tagged packets with the user priority = 100 _B are received on the port.
PQ3	7:6	rw	Priority Queue 3 These 2 bits are used as the priority queue when the tagged packets with the user priority = 011 _B are received on the port.
PQ2	5:4	rw	Priority Queue 2 These 2 bits are used as the priority queue when the tagged packets with the user priority = 010 _B are received on the port.
PQ1	3:2	rw	Priority Queue 1 These 2 bits are used as the priority queue when the tagged packets with the user priority = 001 _B are received on the port.

16 Bits Mode Registers Description

Field	Bits	Type	Description
PQ0	1:0	rw	Priority Queue 0 These 2 bits are used as the priority queue when the tagged packets with the user priority = 000 _B are received on the port.

TOS Priority Map Register

TPM **Offset** **Reset Value**
TOS Priority Map Register **0F_H** **FA50_H**

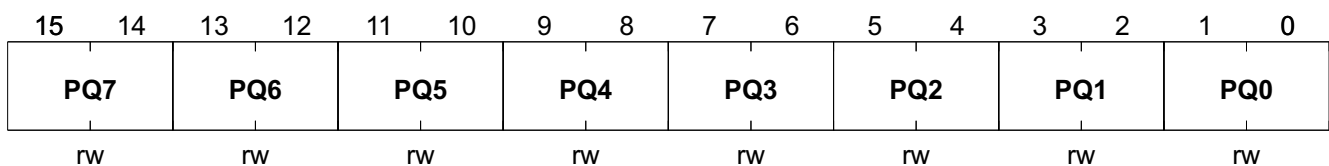

Field	Bits	Type	Description
PQ7	15:14	rw	Priority Queue 7 These 2 bits are used as the priority queue, when the most significant 3 bits in the TOS field are 111 _B 00 _B Queue 0 01 _B Queue 1 10 _B Queue 2 11 _B Queue 3
PQ6	13:12	rw	Priority Queue 6 These 2 bits are used as the priority queue, when the most significant 3 bits in the TOS field are 110 _B
PQ5	11:10	rw	Priority Queue 5 These 2 bits are used as the priority queue, when the most significant 3 bits in the TOS field are 101 _B
PQ4	9:8	rw	Priority Queue 4 These 2 bits are used as the priority queue, when the most significant 3 bits in the TOS field are 100 _B
PQ3	7:6	rw	Priority Queue 3 These 2 bits are used as the priority queue, when the most significant 3 bits in the TOS field are 011 _B
PQ2	5:4	rw	Priority Queue 2 These 2 bits are used as the priority queue, when the most significant 3 bits in the TOS field are 010 _B
PQ1	3:2	rw	Priority Queue 1 These 2 bits are used as the priority queue, when the most significant 3 bits in the TOS field are 001 _B
PQ0	1:0	rw	Priority Queue 0 These 2 bits are used as the priority queue, when the most significant 3 bits in the TOS field are 000 _B

16 Bits Mode Registers Description

System Control Register 2

SC2 **Offset**
System Control Register 2 **10_H** **Reset Value**
0040_H

15	14	13	12	11	10	9	8	7	6	5	4	3	2	1	0
DM_Q3		DM_Q2		DM_Q1		DM_Q0		AD	CC	MP	CCD	BD	SE	ST	
rw		rw		rw		rw		rw	rw	rw	rw	rw	rw	rw	

Field	Bits	Type	Description
DM_Q3	15:14	rw	Discard Mode Q3 Discard Mode (Drop scheme for Packets Classified as Q3) . See Table 19 for details on the drop scheme of each queue
DM_Q2	13:12	rw	Discard Mode Q2 Discard Mode (Drop scheme for Packets Classified as Q2) . See Table 19 for details on the drop scheme of each queue
DM_Q1	11:10	rw	Discard Mode Q1 Discard Mode (Drop scheme for Packets Classified as Q1) . See Table 19 for details on the drop scheme of each queue
DM_Q0	9:8	rw	Discard Mode Q0 Discard Mode (Drop scheme for Packets Classified as Q0) . See Table 19 for details on the drop scheme of each queue
AD	7	rw	Aging Disable Useless in ADM6996FC/FCX/FHX 0 _B Age enable 1 _B Age disable
CC	6	rw	Rx Clock Change to Tx Clock for GPSI Interface 0 _B ADM6996FC/FCX/FHX does not use Tx clock to replace Rx clock when Rx clock stops. 1 _B ADM6996FC/FCX/FHX uses Tx clock to replace Rx clock when Rx clock stops
MP	5	rw	Multicast Packet Counted into the Storm Counter 0 _B Only broadcast packets are counted into the storming counter 1 _B Multicast and broadcast packets are counted into the storming counter
CCD	4	rw	CRC Check Disable 0 _B Check CRC 1 _B Do not check CRC
BD	3	rw	Back Off Disable 0 _B Back-off is enabled 1 _B Back-off is disabled

16 Bits Mode Registers Description

Field	Bits	Type	Description
SE	2	rw	Storming Enable It is used in ADM6996L/F style storm control. 0 _B Disable broadcast/multicast storm protection. 1 _B Enable broadcast/multicast storm protection.
ST	1:0	rw	Storming Threshold[1:0] It is used in ADM6996L/F style storm control.

System Control Register 3

SC3 **Offset**
System Control Register 3 **11_H** **Reset Value**
E300_H

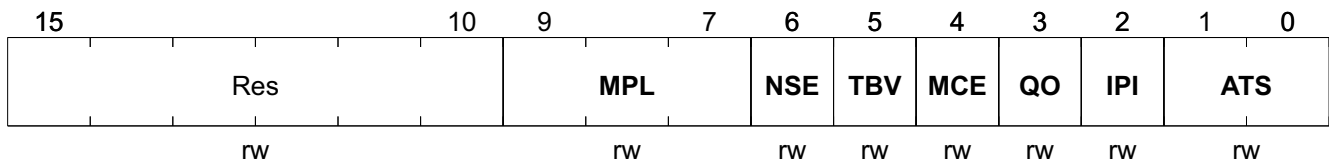

Field	Bits	Type	Description
Res	15:10	rw	Reserved
MPL	9:7	rw	Max Packet Length 000 _B 1518 bytes 001 _B 1536 bytes 010 _B 1664 bytes 110 _B 1522 bytes x11 _B 1784 bytes 10x _B 1784 bytes
NSE	6	rw	New Storming Enable 0 _B Use the ADM6996L/F style storming control 1 _B Use the ADM6996FC/FCX/FHX style storming control
TBV	5	rw	Tag Base VLAN 0 _B Port VLAN 1 _B Tagged VLAN
MCE	4	rw	MAC Clone Enable 0 _B MAC Clone is disabled 1 _B MAC Clone is enabled
QO	3	rw	Queue Option It ' s the test for the designer in the queue control.
IPI	2	rw	Interrupt Polarity Inverter 0 _B The interrupt signal is active pull low 1 _B The interrupt signal is active pull high

16 Bits Mode Registers Description

Field	Bits	Type	Description
ATS	1:0	rw	Aging Timer Select 00 _B 300 Seconds 01 _B 75 Seconds 10 _B 18 Seconds 11 _B 1 Second

System Control Register 4

SC4 **Offset**
System Control Register 4 **12_H** **Reset Value**
3600_H

15	14	13	12	11	10	9	8	7	6	5	4	3	2	1	0
DP	DCS	Res	TLE	Res	O5FL	O4FL	O3FL	PI	O2FL	DUAL*	O1FL	LED*	O0FL		
rw	rw	rw	rw	rw	rw	rw	rw	rw	rw	rw	rw	rw	rw		

Field	Bits	Type	Description
DP	15	rw	Drop Packet When Excessive Collision Happen 0 _B Do not drop 1 _B Drop
DCS	14	rw	Duplex and Col Separate 0 _B Indicate the duplex and collision status at the same time 1 _B Indicate the duplex status only
Res	13:12	rw	Reserved
TLE	11	rw	Ten Limit Enable This function works only when Full Flow Control/Half Back Pressure is enabled. 0 _B The switch will not ignore 10 Mbit/s paths even when the ten limit reaches 1 _B The switch will forward packets with Multicast, Broadcast, or Unicast but not learned DA addresses from 100 Mbit/s only to 100 Mbit/s ports and ignore the 10M paths when the ten limit reaches. This function allows the switch to balance the high and the low speed
Res	10:9	rw	Reserved
O5FL	8	rw	OLD P5 First Lock 0 _B First Lock is disabled 1 _B First Lock is enabled
O4FL	7	rw	OLD P4 First Lock 0 _B First Lock is disabled 1 _B First Lock is enabled
O3FL	6	rw	OLD P3 First Lock 0 _B First Lock is disabled 1 _B First Lock is enabled

16 Bits Mode Registers Description

Field	Bits	Type	Description
PI	5	rw	Pause Ignore 0 _B Do not ignore Pause packets 1 _B Ignore Pause packets in half duplex or in full duplex when flow control is not enabled
O2FL	4	rw	OLD P2 First Lock 0 _B First Lock is disabled 1 _B First Lock is enabled
DUAL-COLOR-EE	3	rw	Dual Color in MDC / MDIO with CPU See Chapter 3.23 LED Display for more detail information. 0 _B Single Color 1 _B Dual Color
O1FL	2	rw	OLD P1 First Lock 0 _B First Lock is disabled 1 _B First Lock is enabled
LED-ENABLE	1	rw	LED Enable 0 _B Disable 1 _B Enable
O0FL	0	rw	OLD P0 First Lock 0 _B First Lock is disabled 1 _B First Lock is enabled

Port 0 Security Option

Port Spanning Tree State and Forward Group Port Map.

P0SO **Offset** **Reset Value**
Port 0 Security Option **13_H** **01D5_H**

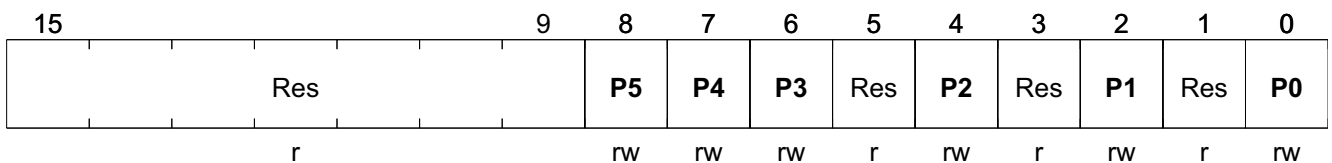

Field	Bits	Type	Description
Res	15:9	r	Reserved
P5	8	rw	Port 5 is a Member of the Forwarding Group 0 _B Port 5 is not a member 1 _B Port 5 is a member
P4	7	rw	Port 4 is a Member of the Forwarding Group 0 _B Port 4 is not a member 1 _B Port 4 is a member
P3	6	rw	Port 3 is a Member of the Forwarding Group 0 _B Port 3 is not a member 1 _B Port 3 is a member
Res	5	r	Reserved

16 Bits Mode Registers Description

Field	Bits	Type	Description
P2	4	rw	Port 2 is a Member of the Forwarding Group 0 _B Port 2 is not a member 1 _B Port 2 is a member
Res	3	r	Reserved
P1	2	rw	Port 1 is a Member of the Forwarding Group 0 _B Port 1 is not a member 1 _B Port 1 is a member
Res	1	r	Reserved
P0	0	rw	Port 0 is a Member of the Forwarding Group 0 _B Port 0 is not a member 1 _B Port 0 is a member

Similar Registers

Table 40 PxSO Registers

Register Short Name	Register Long Name	Offset Address	Page Number
P1SO	Port 1 Security Option	14 _H	
P2SO	Port 2 Security Option	15 _H	
P3SO	Port 3 Security Option	16 _H	
P4SO	Port 4 Security Option	17 _H	
P5SO	Port 5 Security Option	18 _H	

Unicast Port Map andForward Group Port Map

UFGPM **Offset** **Reset Value**
Unicast Port Map andForward Group Port **19_H** **FFD5_H**
Map

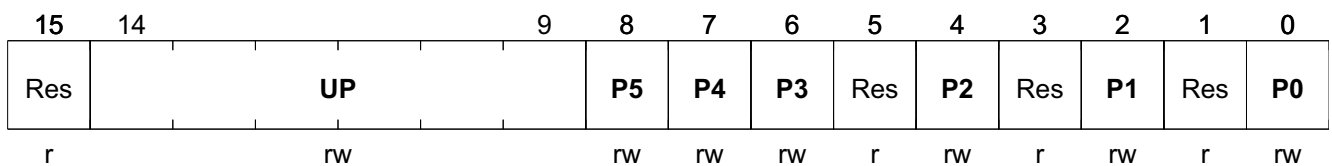

Field	Bits	Type	Description
Res	15	r	Reserved
UP	14:9	rw	Unicast Portmap Always 111111 _B
P5	8	rw	Port 5 is a Member of the Forwarding Group 0 _B Port 5 is not a member 1 _B Port 5 is a member
P4	7	rw	Port 4 is a Member of the Forwarding Group 0 _B Port 4 is not a member 1 _B Port 4 is a member

16 Bits Mode Registers Description

Field	Bits	Type	Description
P3	6	rw	Port 3 is a Member of the Forwarding Group 0 _B Port 3 is not a member 1 _B Port 3 is a member
Res	5	r	Reserved
P2	4	rw	Port 2 is a Member of the Forwarding Group 0 _B Port 2 is not a member 1 _B Port 2 is a member
Res	3	r	Reserved
P1	2	rw	Port 1 is a Member of the Forwarding Group 0 _B Port 1 is not a member 1 _B Port 1 is a member
Res	1	r	Reserved
P0	0	rw	Port 0 is a Member of the Forwarding Group 0 _B Port 0 is not a member 1 _B Port 0 is a member

Broadcast Port Map and Forward Group Port Map

BFGPM **Offset** **Reset Value**
Broadcast Port Map and Forward Group Port Map **1A_H** **FFD5_H**

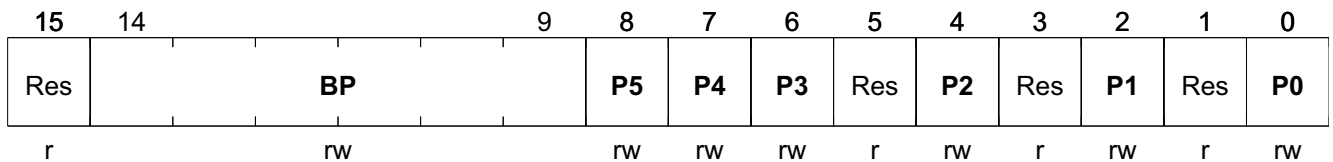

Field	Bits	Type	Description
Res	15	r	Reserved
BP	14:9	rw	Broadcast Portmap Always 111111 _B
P5	8	rw	Port 5 is a Member of the Forwarding Group 0 _B Port 5 is not a member 1 _B Port 5 is a member
P4	7	rw	Port 4 is a Member of the Forwarding Group 0 _B Port 4 is not a member 1 _B Port 4 is a member
P3	6	rw	Port 3 is a Member of the Forwarding Group 0 _B Port 3 is not a member 1 _B Port 3 is a member
Res	5	r	Reserved

16 Bits Mode Registers Description

Field	Bits	Type	Description
P1	2	rw	Port 1 is a member of the Forwarding Group 0 _B Port 1 is not a member 1 _B Port 1 is a member
Res	1	r	Reserved
P0	0	rw	Port 0 is a member of the Forwarding Group 0 _B Port 0 is not a member 1 _B Port 0 is a member

Reserve Port Map and Forward Group Port Map

RFGPM **Offset** **Reset Value**
Reserve Port Map and Forward Group Port Map **1C_H** **FFD5_H**

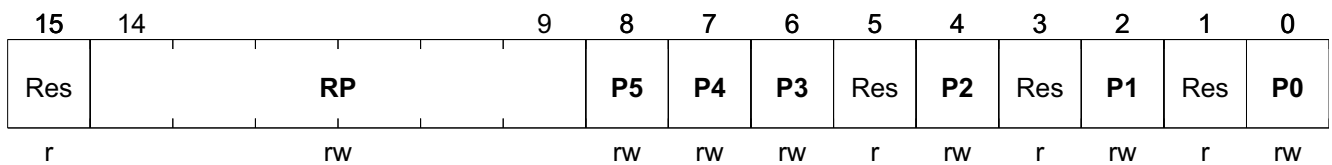

Field	Bits	Type	Description
Res	15	r	Reserved
RP	14:9	rw	Reserve Portmap Always 111111 _B
P5	8	rw	Port 5 is a member of the Forwarding Group 0 _B Port 5 is not a member 1 _B Port 5 is a member
P4	7	rw	Port 4 is a member of the Forwarding Group 0 _B Port 4 is not a member 1 _B Port 4 is a member
P3	6	rw	Port 3 is a member of the Forwarding Group 0 _B Port 3 is not a member 1 _B Port 3 is a member
Res	5	r	Reserved
P2	4	rw	Port 2 is a member of the Forwarding Group 0 _B Port 2 is not a member 1 _B Port 2 is a member
Res	3	r	Reserved
P1	2	rw	Port 1 is a member of the Forwarding Group 0 _B Port 1 is not a member 1 _B Port 1 is a member
Res	1	r	Reserved

16 Bits Mode Registers Description

VPEFGPM **Offset**
VLAN Priority Enable and Forward Group **1E_H**
Port Map **Reset Value**
81D5_H

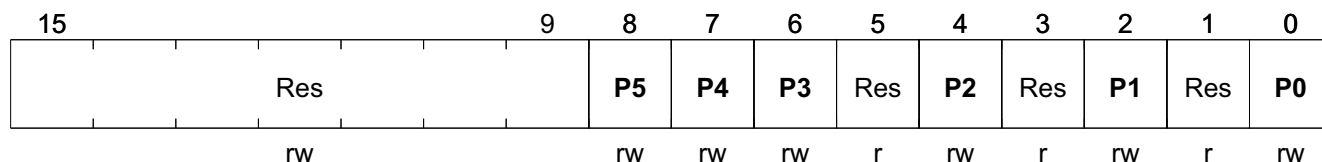

Field	Bits	Type	Description
Res	15:9	rw	Reserved
P5	8	rw	Port 5 is a member of the Forwarding Group 0 _B Port 5 is not a member 1 _B Port 5 is a member
P4	7	rw	Port 4 is a member of the Forwarding Group 0 _B Port 4 is not a member 1 _B Port 4 is a member
P3	6	rw	Port 3 is a member of the Forwarding Group 0 _B Port 3 is not a member 1 _B Port 3 is a member
Res	5	r	Reserved
P2	4	rw	Port 2 is a member of the Forwarding Group 0 _B Port 2 is not a member 1 _B Port 2 is a membe
Res	3	r	Reserved
P1	2	rw	Port 1 is a member of the Forwarding Group 0 _B Port 1 is not a member 1 _B Port 1 is a member
Res	1	r	Reserved
P0	0	rw	Port 0 is a member of the Forwarding Group 0 _B Port 0 is not a member 1 _B Port 0 is a member

Service Priority Enable and Forward Group Port Map

SPEFGPM **Offset**
Service Priority Enable and Forward Group **1F_H**
Port Map **Reset Value**
FFD5_H

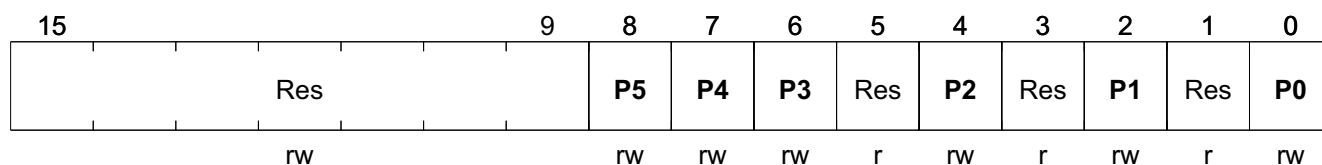

16 Bits Mode Registers Description

Field	Bits	Type	Description
Res	15:9	rw	Reserved
P5	8	rw	Port 5 is a member of the Forwarding Group 0 _B Port 5 is not a member 1 _B Port 5 is a member
P4	7	rw	Port 4 is a member of the Forwarding Group 0 _B Port 4 is not a member 1 _B Port 4 is a member
P3	6	rw	Port 3 is a member of the Forwarding Group 0 _B Port 3 is not a member 1 _B Port 3 is a member
Res	5	r	Reserved
P2	4	rw	Port 2 is a member of the Forwarding Group 0 _B Port 2 is not a member 1 _B Port 2 is a member
Res	3	r	Reserved
P1	2	rw	Port 1 is a member of the Forwarding Group 0 _B Port 1 is not a member 1 _B Port 1 is a member
Res	1	r	Reserved
P0	0	rw	Port 0 is a member of the Forwarding Group 0 _B Port 0 is not a member 1 _B Port 0 is a member

Input Force No Tag and Forward Group Port Map

IFNTFGPM	Offset	Reset Value
Input Force No Tag and Forward Group Port Map	20_H	FFD5_H

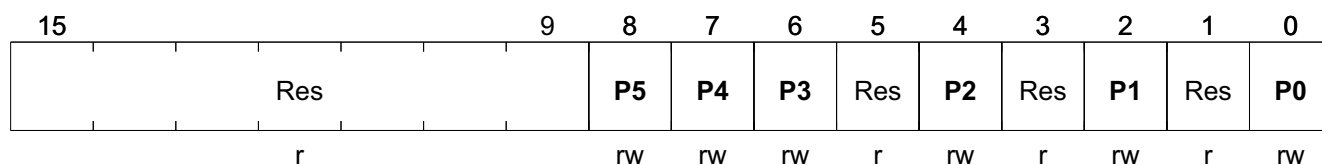

Field	Bits	Type	Description
Res	15:9	r	Reserved
P5	8	rw	Port 5 is a member of the Forwarding Group 0 _B Port 5 is not a member 1 _B Port 5 is a member
P4	7	rw	Port 4 is a member of the Forwarding Group 0 _B Port 4 is not a member 1 _B Port 4 is a member

16 Bits Mode Registers Description

Field	Bits	Type	Description
P3	6	rw	Port 3 is a member of the Forwarding Group 0 _B Port 3 is not a member 1 _B Port 3 is a member
Res	5	r	Reserved
P2	4	rw	Port 2 is a member of the Forwarding Group 0 _B Port 2 is not a member 1 _B Port 2 is a member
Res	3	r	Reserved
P1	2	rw	Port 1 is a member of the Forwarding Group 0 _B Port 1 is not a member 1 _B Port 1 is a member
Res	1	r	Reserved
P0	0	rw	Port 0 is a member of the Forwarding Group 0 _B Port 0 is not a member 1 _B Port 0 is a member

Ingress Filter and Forward Group Port Map

IFFGPM **Offset** **Reset Value**
Ingress Filter and Forward Group Port Map **21_H** **FFD5_H**

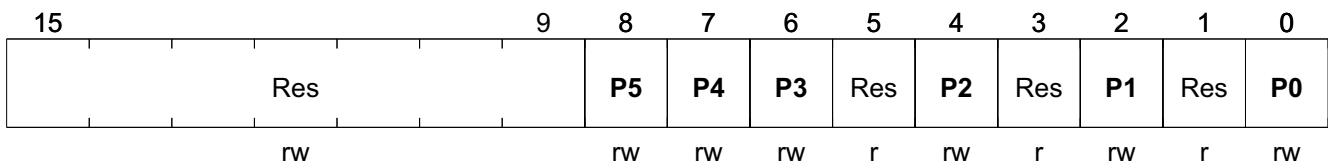

Field	Bits	Type	Description
Res	15:9	rw	Reserved
P5	8	rw	Port 5 is a member of the Forwarding Group 0 _B Port 5 is not a member 1 _B Port 5 is a member
P4	7	rw	Port 4 is a member of the Forwarding Group 0 _B Port 4 is not a member 1 _B Port 4 is a member
P3	6	rw	Port 3 is a member of the Forwarding Group 0 _B Port 3 is not a member 1 _B Port 3 is a member
Res	5	r	Reserved
P2	4	rw	Port 2 is a member of the Forwarding Group 0 _B Port 2 is not a member 1 _B Port 2 is a member
Res	3	r	Reserved

16 Bits Mode Registers Description

Field	Bits	Type	Description
P1	2	rw	Port 1 is a member of the Forwarding Group 0 _B Port 1 is not a member 1 _B Port 1 is a member
Res	1	r	Reserved
P0	0	rw	Port 0 is a member of the Forwarding Group 0 _B Port 0 is not a member 1 _B Port 0 is a member

VLAN Security Disable and Forward Group Port Map

VSDFGPM **Offset**
VLAN Security Disable and Forward Group **22_H**
Port Map **Reset Value**
FFD5_H

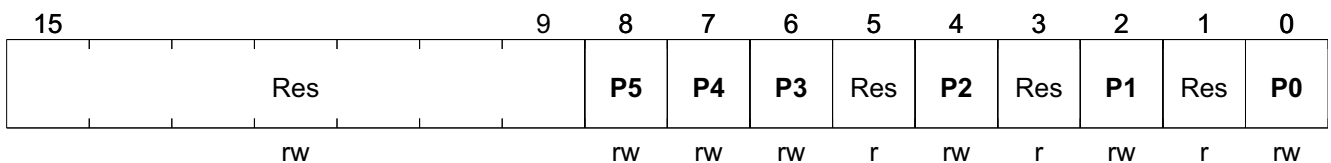

Field	Bits	Type	Description
Res	15:9	rw	Reserved
P5	8	rw	Port 5 is a member of the Forwarding Group 0 _B Port 5 is not a member 1 _B Port 5 is a member
P4	7	rw	Port 4 is a member of the Forwarding Group 0 _B Port 4 is not a member 1 _B Port 4 is a member
P3	6	rw	Port 3 is a member of the Forwarding Group 0 _B Port 3 is not a member 1 _B Port 3 is a member
Res	5	r	Reserved
P2	4	rw	Port 2 is a member of the Forwarding Group 0 _B Port 2 is not a member 1 _B Port 2 is a member
Res	3	r	Reserved
P1	2	rw	Port 1 is a member of the Forwarding Group 0 _B Port 1 is not a member 1 _B Port 1 is a member
Res	1	r	Reserved
P0	0	rw	Port 0 is a member of the Forwarding Group 0 _B Port 0 is not a member 1 _B Port 0 is a member

IGMP/MLDTRAP Enable and Input Jam Threshold Register

IMEIJT	Offset	Reset Value
IGMP/MLDTRAP Enable and Input Jam Threshold Register	25_H	2000_H



Field	Bits	Type	Description
Q1W	15:12	ro	Queue 1 Weight See Table 33 Priority Queue Weight Ratio for more detail information.
Res	11:6	rw	Reserved
IJT	5:0	rw	Input Jam Threshold

Queue 2 Weight, VID Exist Check, and PPPOE Port Only

Q2WVECPO	Offset	Reset Value
Queue 2 Weight, VID Exist Check, and PPPOE Port Only	26_H	4000_H

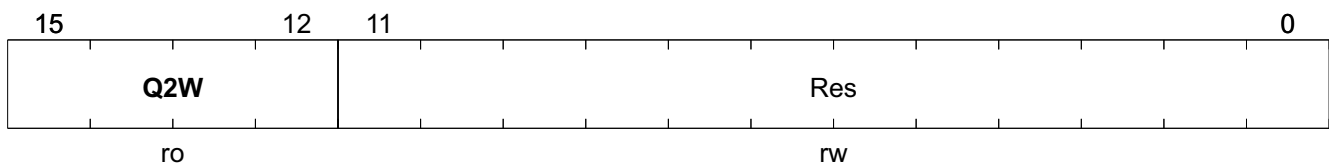

Field	Bits	Type	Description
Q2W	15:12	ro	Queue 2 Weight See Table 33 Priority Queue Weight Ratio for more detail information.
Res	11:0	rw	Reserved

Queue 3 Weight, Back to Port VLAN, and Admit Only VLAN-Tagged

Q3WBPVAO	Offset	Reset Value
Queue 3 Weight, Back to Port VLAN, and Admit Only VLAN-Tagged	27_H	8000_H

16 Bits Mode Registers Description

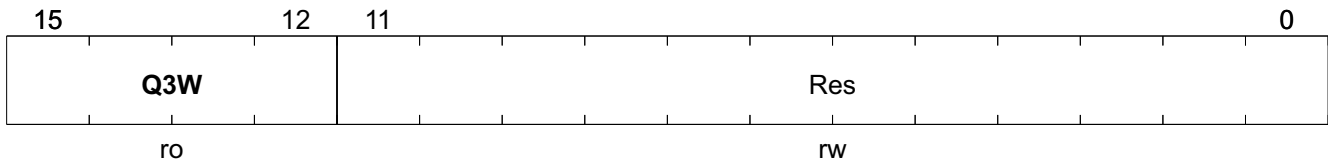

Field	Bits	Type	Description
Q3W	15:12	ro	Queue 3 Weight See Table 33 Priority Queue Weight Ratio for more detail information.
Res	11:0	rw	Reserved

Input Double Tag Enable, and P0VID[11:4]

IDTEP	Offset	Reset Value
Input Double Tag Enable, and P0VID[11:4]	28 _H	0000 _H

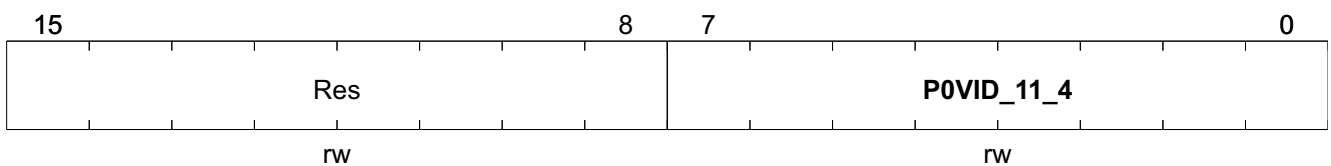

Field	Bits	Type	Description
Res	15:8	rw	Reserved
P0VID_11_4	7:0	rw	P0VID[11:4] VID bit 11 ~ 4 fo Port 0

Output Double Tag Enable, and P1VID[11:4]

ODTEP	Offset	Reset Value
Output Double Tag Enable, and P1VID[11:4]	29 _H	0000 _H

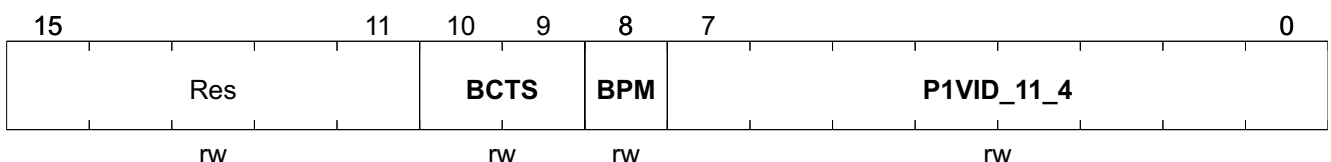

Field	Bits	Type	Description
Res	15:11	rw	Reserved

16 Bits Mode Registers Description

Field	Bits	Type	Description
BCTS	10:9	rw	Bandwidth Control Timer Select 00 _B 8 ms, 64Kbps step, apply to 64Kbps~2.2Mbps 01 _B 1 ms, 512Kbps step, apply to 512Kbps~18Mbps 10 _B 40 us, 200Kbps step, apply to 200Kbps~100Mbps 11 _B 500 us, 16Kbps step, apply to 16Kbps~32Mbps
BPM	8	rw	Back Pressure Mechanism 0 _B Exit collision state when CRS goes low 1 _B Exit collision state when RXDV goes low
P1VID_11_4	7:0	rw	P1VID[11:4] VID bit 11 ~ 4 of Port 1.

Output Tag Bypass, and P2VID[11:4]

OTBP	Offset	Reset Value
Output Tag Bypass, and P2VID[11:4]	2A_H	0000_H

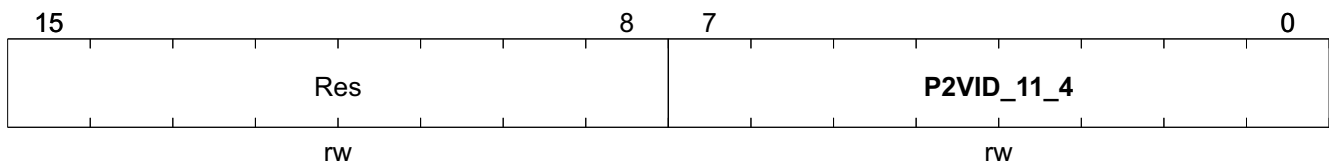

Field	Bits	Type	Description
Res	15:8	rw	Reserved
P2VID_11_4	7:0	rw	P2VID[11:4] VID bit 11 ~ 4 of Port 2.

P3VID[11:4], and P4VID[11:4]

P11_4	Offset	Reset Value
P3VID[11:4], and P4VID[11:4]	2B_H	0000_H

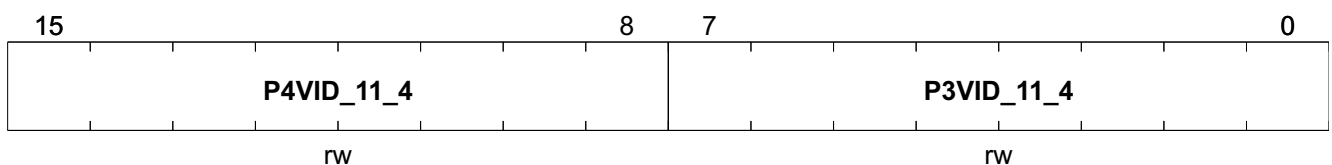

Field	Bits	Type	Description
P4VID_11_4	15:8	rw	P4VID[11:4] VID bit 11 ~ 4 of Port 4.
P3VID_11_4	7:0	rw	P3VID[11:4] VID bit 11 ~ 4 of Port 3.

16 Bits Mode Registers Description

Reserved Address Control, and P5VID[11:4]

RACP	Offset	Reset Value
Reserved Address Control, and P5VID[11:4]	2C _H	D000 _H

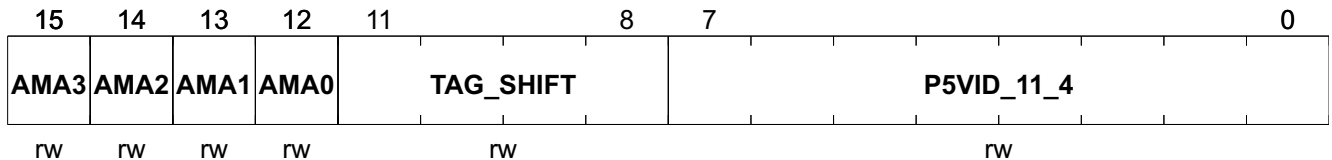

Field	Bits	Type	Description
AMA3	15	rw	Action of MAC Address 3 The Action of MAC Address = 0180C2000010 _H ~ 0180C20000FF _H
AMA2	14	rw	Action of MAC Address 2 The Action of MAC Address = 0180C2000002 _H ~ 0180C200000F _H
AMA1	13	rw	Action of MAC Address 1 The Action of MAC Address = 0180C2000001 _H
AMA0	12	rw	Action of MAC Address 0 The Action of MAC Address = 0180C2000000 _H
TAG_SHIFT	11:8	rw	Tag Shift
P5VID_11_4	7:0	rw	P5VID[11:4] VID bit 11 ~ 4 of Port 5

PHY Control Register

PHYC	Offset	Reset Value
PHY Control Register	2D _H	4442 _H

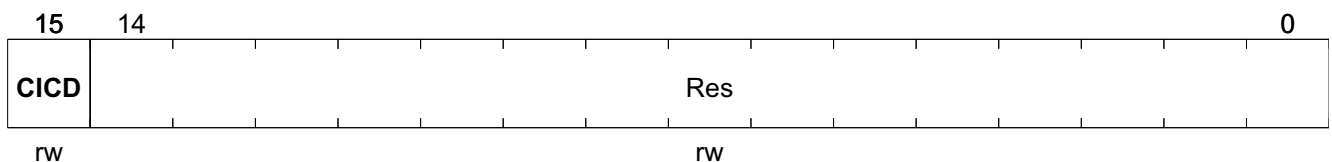

Field	Bits	Type	Description
CICD	15	rw	Chip ID Check Disable 0 _B Check CHIP ID in 32 bit SDC/SDO 1 _B Do not check CHIP ID in 32 bit SDC/SDIO
Res	14:0	rw	Reserved

PHY Restart Register

16 Bits Mode Registers Description

PR **Offset**
PHY Restart Register **2F_H** **Reset Value**
0000_H

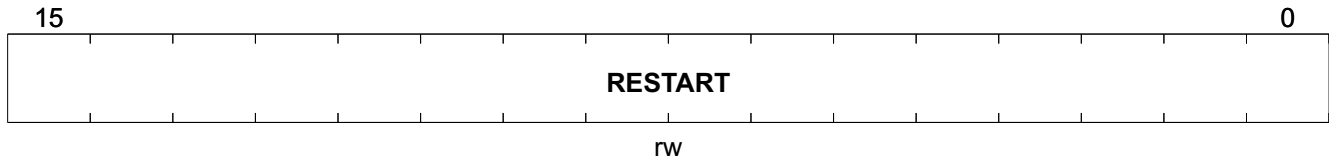

Field	Bits	Type	Description
RESTART	15:0	rw	Restart ADM6996FC/FCX/FHX writes this register to restart all the PHYs in the switch. The value written is not important.

Miscellaneous Register

MISC **Offset**
Miscellaneous Register **30_H** **Reset Value**
0987_H

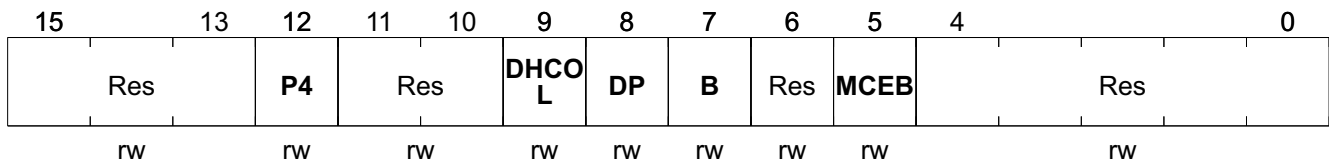

Field	Bits	Type	Description
Res	15:13	rw	Reserved
P4	12	rw	Port 4 LED Mode 0 _B LinkAct/DupCol/Speed. 1 _B Link/Act/Speed.
Res	11:10	rw	Reserved
DHCOL	9	rw	Dual Speed Hub COL_LED Enable 0 _B Normal LED display. 1 _B Dual Speed Hub LED display. Port0 Col LED: 10M Col LED. Port1 Col LED: 100M Col LED.
DP	8	rw	Drop Packets Drop packets when the link partner does not follow the PAUSE protocol. 0 _B Disable. 1 _B Enable to drop packets.
B	7	rw	BYPASS Bypass Tag/Untag function. 0 _B Disable. 1 _B Enable to bypass Tag/Untag function
Res	6	rw	Reserved

16 Bits Mode Registers Description

Field	Bits	Type	Description
MCEB	5	rw	MAC Clone Enable Bits select 0 _B Select 1 bit MAC Clone function. 1 _B Select 2 bits MAC Clone function.
Res	4:0	rw	Reserved

Basic Bandwidth Control Register 0

BBC0 **Offset**
Basic Bandwidth Control Register 0 **31_H** **Reset Value**
0000_H

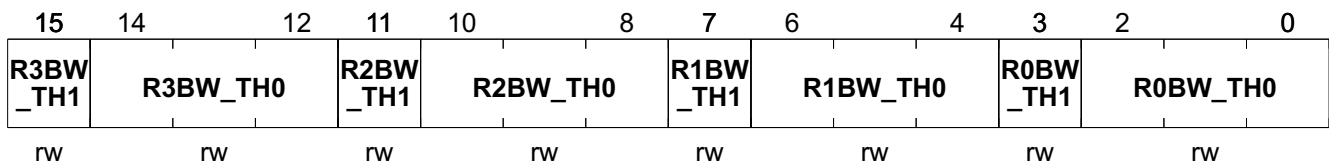

Field	Bits	Type	Description
R3BW_TH1	15	rw	Port 3 Receive Bandwidth Maximum[3]. See register 0033 _H , P3RBCE for more detail.
R3BW_TH0	14:12	rw	Port 3 Receive Bandwidth Configuration See register 0033 _H , P3RBCE for more detail.
R2BW_TH1	11	rw	Port 2 Receive Bandwidth Maximum[3]. See register 0033 _H , P2RBCE for more detail.
R2BW_TH0	10:8	rw	Port 2 Receive Bandwidth Configuration See register 0033 _H , P2RBCE for more detail.
R1BW_TH1	7	rw	Port 1 Receive Bandwidth Maximum[3]. See register 0033 _H , P1RBCE for more detail.
R1BW_TH0	6:4	rw	Port 1 Receive Bandwidth Configuration See register 0033 _H , P1RBCE for more detail.
R0BW_TH1	3	rw	Port 0 Receive Bandwidth Maximum[3]. See register 0033 _H , P0RBCE for more detail.
R0BW_TH0	2:0	rw	Port 0 Receive Bandwidth Configuration See register 0033 _H , P0RBCE for more detail.

Basic Bandwidth Control Register 1

BBC1 **Offset**
Basic Bandwidth Control Register 1 **32_H** **Reset Value**
0000_H

16 Bits Mode Registers Description

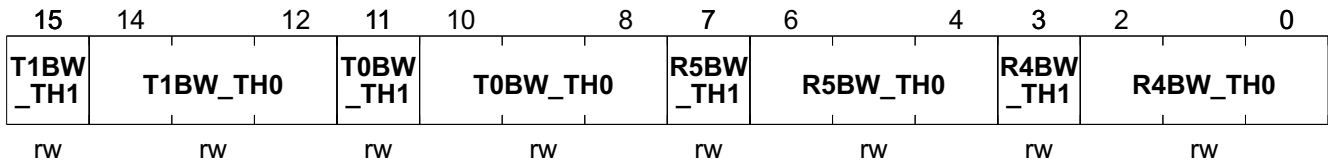

Field	Bits	Type	Description
T1BW_TH1	15	rw	Port 1 Transmit Bandwidth Maximum[3]. See register 0033 _H , P1TBCE for more detail.
T1BW_TH0	14:12	rw	Port 1 Transmit Bandwidth Maximum[2:0]. See register 0033 _H , P1TBCE for more detail.
T0BW_TH1	11	rw	Port 0 Transmit Bandwidth Maximum[3]. See register 0033 _H , P0TBCE for more detail.
T0BW_TH0	10:8	rw	Port 0 Transmit Bandwidth Maximum[2:0]. See register 0033 _H , P0TBCE for more detail.
R5BW_TH1	7	rw	Port 5 Receive Bandwidth Maximum[3]. See register 0033 _H , P5RBCE for more detail.
R5BW_TH0	6:4	rw	Port 5 Receive Bandwidth Configuration See register 0033 _H , P5RBCE for more detail.
R4BW_TH1	3	rw	Port 4 Receive Bandwidth Maximum[3]. See register 0033 _H , P4RBCE for more detail.
R4BW_TH0	2:0	rw	Port 4 Receive Bandwidth Configuration See register 0033 _H , P4RBCE for more detail.

Bandwidth Control Enable Register

BCE	Offset	Reset Value
Bandwidth Control Enable Register	33_H	0000_H

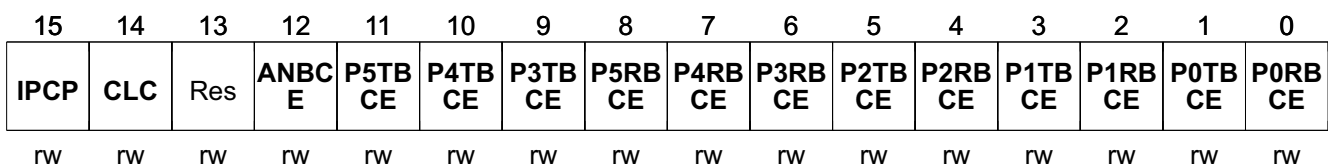

Field	Bits	Type	Description
IPCP	15	rw	Invert P4 Clock in PCS 0 _D Disable 1 _D Enable
CLC	14	rw	Check the Length of CRS 0 _D Enable 1 _D Disable
Res	13	rw	Reserved

16 Bits Mode Registers Description

Field	Bits	Type	Description
ANBCE	12	rw	ADM6996FC/FCX/FHX New Bandwidth Control Enable 0 _B Disable 1 _B Enable
P5TBCE	11	rw	Port 5 Transmit Bandwidth Control Enable The transmit bandwidth is { T5BW_TH3, T5BW_TH2, T5BW_TH1, T5BW_TH0 , 000000 _B } kbit/s. K = 1000. 0 _B Disable 1 _B Enable
P4TBCE	10	rw	Port 4 Transmit Bandwidth Control Enable The transmit bandwidth is { T4BW_TH3, T4BW_TH2, T4BW_TH1, T4BW_TH0 , 000000 _B } kbit/s. K = 1000. 0 _B Disable 1 _B Enable
P3TBCE	9	rw	Port 3 Transmit Bandwidth Control Enable The transmit bandwidth is { T3BW_TH3, T3BW_TH2, T3BW_TH1, T3BW_TH0 , 000000 _B } kbit/s. K = 1000. 0 _B Disable 1 _B Enable
P5RBCE	8	rw	Port 5 Receive Bandwidth Control Enable The receive bandwidth is { R5BW_TH3, R5BW_TH2, R5BW_TH1, R5BW_TH0 , 000000 _B } kbit/s. K = 1000. 0 _B Disable 1 _B Enable
P4RBCE	7	rw	Port 4 Receive Bandwidth Control Enable The receive bandwidth is { R4BW_TH3, R4BW_TH2, R4BW_TH1, R4BW_TH0 , 000000 _B } kbit/s. K = 1000. 0 _B Disable 1 _B Enable
P3RBCE	6	rw	Port 3 Receive Bandwidth Control Enable The receive bandwidth is { R3BW_TH3, R3BW_TH2, R3BW_TH1, R3BW_TH0 , 000000 _B } kbit/s. K = 1000. 0 _B Disable 1 _B Enable
P2TBCE	5	rw	Port 2 Transmit Bandwidth Control Enable The transmit bandwidth is { T2BW_TH3, T2BW_TH2, T2BW_TH1, T2BW_TH0 , 000000 _B } kbit/s. K = 1000. 0 _B Disable 1 _B Enable
P2RBCE	4	rw	Port 2 Receive Bandwidth Control Enable The receive bandwidth is { R2BW_TH3, R2BW_TH2, R2BW_TH1, R2BW_TH0 , 000000 _B } kbit/s. K = 1000. 0 _B Disable 1 _B Enable
P1TBCE	3	rw	Port 1 Transmit Bandwidth Control Enable The transmit bandwidth is { T1BW_TH3, T1BW_TH2, T1BW_TH1, T1BW_TH0 , 000000 _B } kbit/s. K = 1000. 0 _B Disable 1 _B Enable

16 Bits Mode Registers Description

Field	Bits	Type	Description
P1RBCE	2	rw	Port 1 Receive Bandwidth Control Enable The receive bandwidth is { R1BW_TH3 , R1BW_TH2 , R1BW_TH1 , R1BW_TH0 , 000000 _B } kbit/s. K = 1000. 0 _B Disable 1 _B Enable
P0TBCE	1	rw	Port 0 Transmit Bandwidth Control Enable The transmit bandwidth is { T0BW_TH3 , T0BW_TH2 , T0BW_TH1 , T0BW_TH0 , 000000 _B } kbit/s. K = 1000. 0 _B Disable 1 _B Enable
P0RBCE	0	rw	Port 0 Receive Bandwidth Control Enable The receive bandwidth is { R0BW_TH3 , R0BW_TH2 , R0BW_TH1 , R0BW_TH0 , 000000 _B } kbit/s. K = 1000. 0 _B Disable 1 _B Enable

Extended Bandwidth Control Register 0

EBC0 **Offset** **Reset Value**
Extended Bandwidth Control Register 0 **34_H** **0000_H**

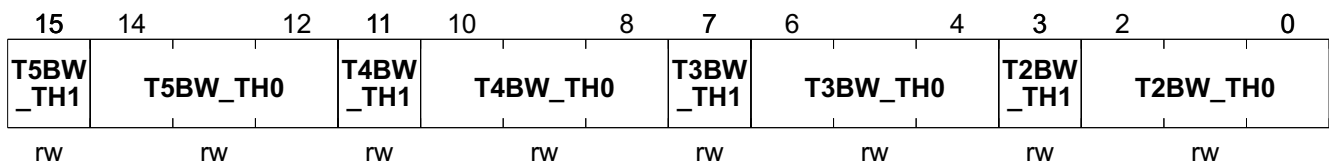

Field	Bits	Type	Description
T5BW_TH1	15	rw	Port 5 Transmit Bandwidth Maximum[3]. See register 0033 _H , P5TBCE for more detail.
T5BW_TH0	14:12	rw	Port 5 Transmit Bandwidth Maximum[2:0]. See register 0033 _H , P5TBCE for more detail.
T4BW_TH1	11	rw	Port 4 Transmit Bandwidth Maximum[3]. See register 0033 _H , P4TBCE for more detail.
T4BW_TH0	10:8	rw	Port 4 Transmit Bandwidth Maximum[2:0]. See register 0033 _H , P4TBCE for more detail.
T3BW_TH1	7	rw	Port 3 Transmit Bandwidth Maximum[3]. See register 0033 _H , P3TBCE for more detail.
T3BW_TH0	6:4	rw	Port 3 Transmit Bandwidth Maximum[2:0]. See register 0033 _H , P3TBCE for more detail.
T2BW_TH1	3	rw	Port 2 Transmit Bandwidth Maximum[3]. See register 0033 _H , P2TBCE for more detail.
T2BW_TH0	2:0	rw	Port 2 Transmit Bandwidth Maximum[2:0]. See register 0033 _H , P2TBCE for more detail.

16 Bits Mode Registers Description

Extended Bandwidth Control Register 1

EBC1 **Offset**
Extended Bandwidth Control Register 1 **35_H** **Reset Value**
0000_H

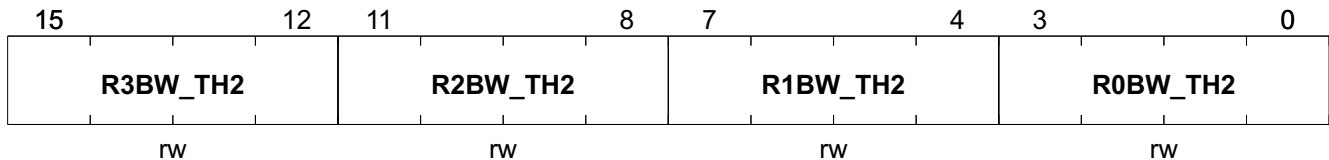

Field	Bits	Type	Description
R3BW_TH2	15:12	rw	Port 3 Receive Bandwidth Maximum[7:4]. See register 0033 _H , P3RBCE for more detail.
R2BW_TH2	11:8	rw	Port 2 Receive Bandwidth Maximum[7:4]. See register 0033 _H , P2RBCE for more detail.
R1BW_TH2	7:4	rw	Port 1 Receive Bandwidth Maximum[7:4]. See register 0033 _H , P1RBCE for more detail.
R0BW_TH2	3:0	rw	Port 0 Receive Bandwidth Maximum[7:4]. See register 0033 _H , P0RBCE for more detail.

Extended Bandwidth Control Register 2

EBC2 **Offset**
Extended Bandwidth Control Register 2 **36_H** **Reset Value**
0000_H

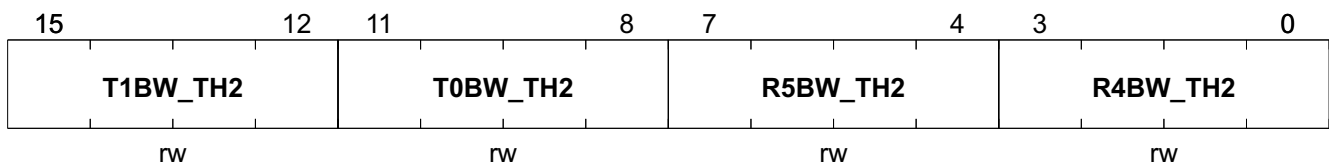

Field	Bits	Type	Description
T1BW_TH2	15:12	rw	Port 1 Transmit Bandwidth Maximum[7:4] See register 0033 _H , P1TBCE for more detail.
T0BW_TH2	11:8	rw	Port 0 Transmit Bandwidth Maximum[7:4]. See register 0033 _H , P0TBCE for more detail.
R5BW_TH2	7:4	rw	Port 5 Receive Bandwidth Maximum[7:4]. See register 0033 _H , P5RBCE for more detail.
R4BW_TH2	3:0	rw	Port 4 Receive Bandwidth Maximum[7:4]. See register 0033 _H , P4RBCE for more detail.

Extended Bandwidth Control Register 3

16 Bits Mode Registers Description

EBC3 **Offset**
Extended Bandwidth Control Register 3 **37_H** **Reset Value**
0000_H

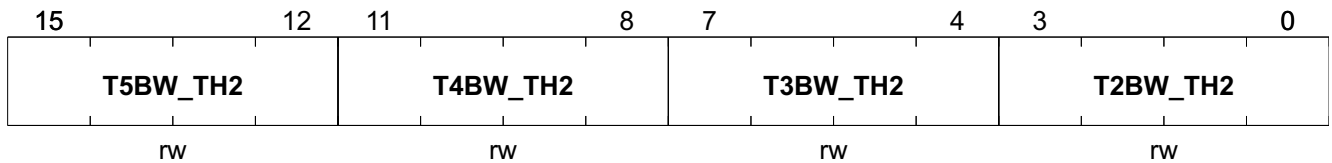

Field	Bits	Type	Description
T5BW_TH2	15:12	rw	Port 5 Transmit Bandwidth Maximum[7:4]. See register 0033 _H , P5TBCE for more detail.
T4BW_TH2	11:8	rw	Port 4 Transmit Bandwidth Maximum[7:4]. See register 0033 _H , P4TBCE for more detail.
T3BW_TH2	7:4	rw	Port 3 Transmit Bandwidth Maximum[7:4]. See register 0033 _H , P3TBCE for more detail.
T2BW_TH2	3:0	rw	Port 2 Transmit Bandwidth Maximum[7:4]. See register 0033 _H , P2TBCE for more detail.

Extended Bandwidth Control Register 4

EBC4 **Offset**
Extended Bandwidth Control Register 4 **38_H** **Reset Value**
0000_H

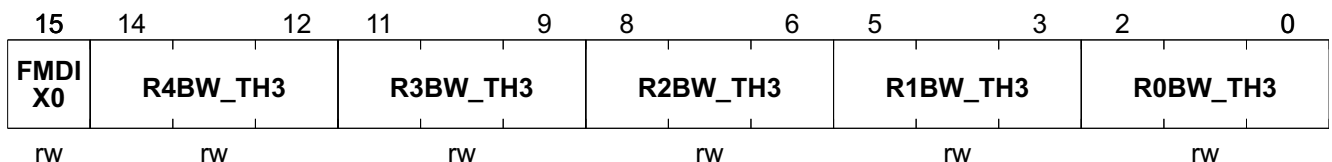

Field	Bits	Type	Description
FMDIX0	15	rw	Port 0 MDIX Control This bit can be used for Port 0 MDI/MDIX selection. It is useful when Port 0 Crossover Auto Detect is disabled and 16 bits management interface (SDC/SDIO) is used. 0 _B Using MDI 1 _B Using MDIX
R4BW_TH3	14:12	rw	Port 4 Receive Bandwidth Maximum[10:8]. See register 0033 _H , P4RBCE for more detail.
R3BW_TH3	11:9	rw	Port 3 Receive Bandwidth Maximum[10:8]. See register 0033 _H , P3RBCE for more detail.
R2BW_TH3	8:6	rw	Port 2 Receive Bandwidth Maximum[10:8]. See register 0033 _H , P2RBCE for more detail.
R1BW_TH3	5:3	rw	Port 1 Receive Bandwidth Maximum[10:8]. See register 0033 _H , P1RBCE for more detail.

16 Bits Mode Registers Description

Field	Bits	Type	Description
R0BW_TH3	2:0	rw	Port 0 Receive Bandwidth Maximum[10:8]. See register 0033 _H , P0RBCE for more detail.

Extended Bandwidth Control Register 5

EBC5 **Offset**
Extended Bandwidth Control Register 5 **39_H** **Reset Value**
0000_H

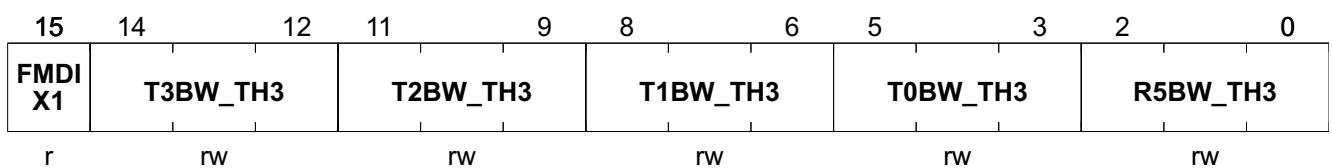

Field	Bits	Type	Description
FMDIX1	15	r	Port 1 MDIX Control This bit can be used for Port 1 MDI/MDIX selection. It is useful when Port 1 Crossover Auto Detect is disabled and 16 bits management interface (SDC/SDIO) is used. 0 _B Using MDI 1 _B Using MDIX
T3BW_TH3	14:12	rw	Port 3 Transmit Bandwidth Maximum[10:8]. See register 0033 _H , P3TBCE for more detail.
T2BW_TH3	11:9	rw	Port 2 Transmit Bandwidth Maximum[10:8]. See register 0033 _H , P2TBCE for more detail.
T1BW_TH3	8:6	rw	Port 1 Transmit Bandwidth Maximum[10:8]. See register 0033 _H , P1TBCE for more detail.
T0BW_TH3	5:3	rw	Port 0 Transmit Bandwidth Maximum[10:8]. See register 0033 _H , P0TBCE for more detail.
R5BW_TH3	2:0	rw	Port 5 Receive Bandwidth Maximum[10:8]. See register 0033 _H , P5RBCE for more detail.

Default VLAN Member and Extended Bandwidth Control Register 6

DVMEBC6 **Offset**
Default VLAN Member and Extended **3A_H** **Reset Value**
Bandwidth Control Register 6 **0FC0_H**

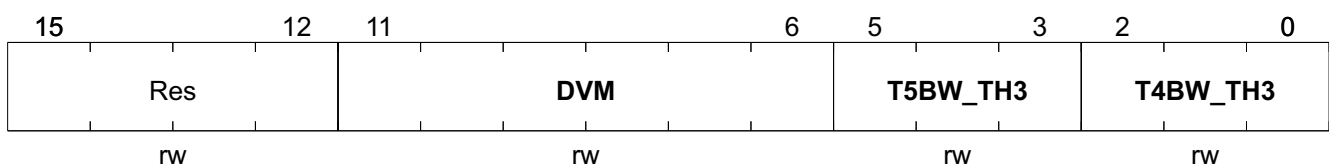

16 Bits Mode Registers Description

Field	Bits	Type	Description
Res	15:12	rw	Reserved
DVM	11:6	rw	Default VLAN Member Always 111111 _B
T5BW_TH3	5:3	rw	Port 5 Transmit Bandwidth Maximum[10:8]. See register 0033 _H , P5TBCE for more detail.
T4BW_TH3	2:0	rw	Port 4 Transmit Bandwidth Maximum[10:8]. See register 0033 _H , P4TBCE for more detail.

New Storm Register 0

NS0		Offset	Reset Value
New Storm Register 0		3B_H	0000_H
15	14	13	12
0	STORM_100_TH		
Res	STORM_D*	STORM_EN	
r	rw	rw	rw

Field	Bits	Type	Description
Res	15	r	Reserved
STORM_DRO P_EN	14	rw	Storm Drop Enable 0 _B Do not drop in the storming period 1 _B Drop in the storming period
STORM_EN	13	rw	Storm Enable 0 _B Disable ADM6996FC/FCX/FHX style broadcast storm protection 1 _B Enable ADM6996FC/FCX/FHX style broadcast storm protection
STORM_100_TH	12:0	rw	100M Threshold See Table 32 for more detail information. It is used when all ports link up in the 100M. The upper bound is reached when the number of the packets received during the 50 ms is over 100M Threshold.

New Storm Register 1

NS1		Offset	Reset Value
New Storm Register 1		3C_H	0000_H
15	14	13	12
0	STORM_10_TH		
FMDI X4	FMDI X3	FMDI X2	
rw	rw	rw	rw

16 Bits Mode Registers Description

Field	Bits	Type	Description
FMDIX4	15	rw	Port 4 MDIX Control This bit can be used for Port 4 MDI/MDIX selection. It is useful when Port 4 Crossover Auto Detect is disabled and 16 bits management interface (SDC/SDIO) is used. 0 _B Using MDI 1 _B Using MDIX
FMDIX3	14	rw	Port 3 MDIX Control This bit can be used for Port 3 MDI/MDIX selection. It is useful when Port 3 Crossover Auto Detect is disabled and 16 bits management interface (SDC/SDIO) is used. 0 _B Using MDI 1 _B Using MDIX
FMDIX2	13	rw	Port 2 MDIX Control This bit can be used for Port 2 MDI/MDIX selection. It is useful when Port 2 Crossover Auto Detect is disabled and 16 bits management interface (SDC/SDIO) is used. 0 _B Using MDI 1 _B Using MDIX
STORM_10_TH	12:0	rw	10M Threshold See Table 32 for more detail information. It is used when one of ports link up in the 10M. The upper bound is reached when the number of the packets received during the 50 ms is over 10M Threshold.

New Reserve Address Control Register 0

NRAC0 **Offset** **Reset Value**
New Reserve Address Control Register 0 **3D_H** **00FD_H**

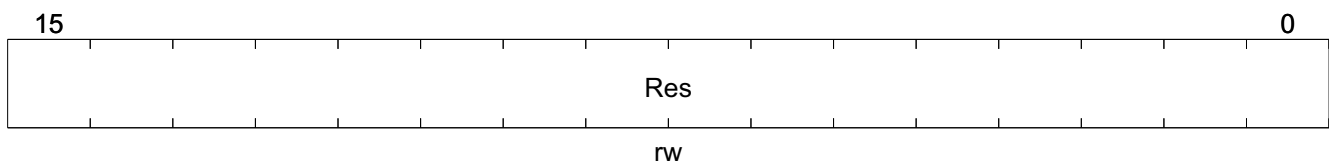

Field	Bits	Type	Description
Res	15:0	rw	Reserved

New Reserve Address Control Register 1

NRAC1 **Offset** **Reset Value**
New Reserve Address Control Register 1 **3E_H** **0000_H**

16 Bits Mode Registers Description

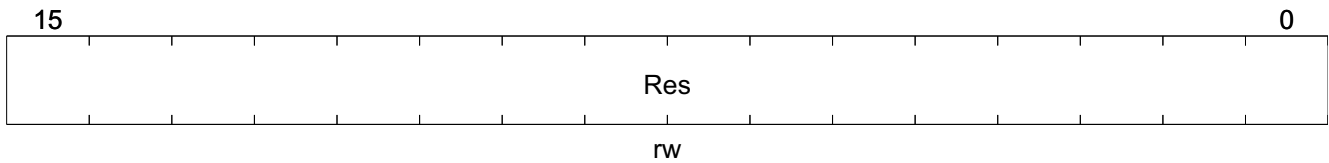

Field	Bits	Type	Description
Res	15:0	rw	Reserved

5.2 EEPROM Extended Registers

VLAN Filter 0 Low

VF0L VLAN Filter 0 Low	Offset 40 _H	Reset Value 003F _H
----------------------------------	----------------------------------	---

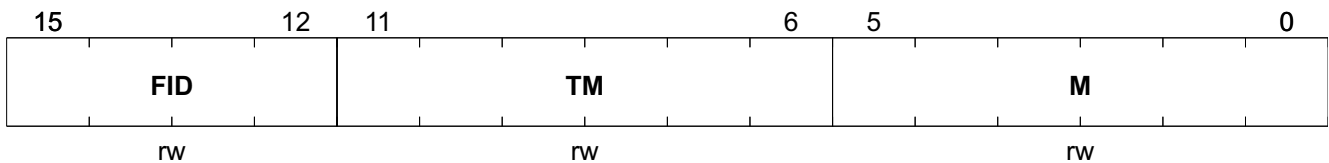

Field	Bits	Type	Description
FID	15:12	rw	FID The forwarding or learning group that the VID is assigned.
TM	11:6	rw	Tagged Member These bits indicate which ports associated with the VID should transmit tagged packets. Tagged Member[x] Description. 0 _B Port x should transmit untagged packets 1 _B Port x should transmit tagged packets
M	5:0	rw	Member These bits indicate which ports are the members of the VLAN. Member[x] Description. 0 _B Port x is not a VLAN member 1 _B Port x is a VLAN member

Similar Registers

Table 41 VFxL Registers

Register Short Name	Register Long Name	Offset Address	Page Number
VF1L	VLAN Filter 1 Low	42 _H	
VF2L	VLAN Filter 2 Low	44 _H	
VF3L	VLAN Filter 3Low	46 _H	
VF4L	VLAN Filter 4 Low	48 _H	

16 Bits Mode Registers Description

Table 41 VFL Registers (cont'd)

Register Short Name	Register Long Name	Offset Address	Page Number
VF5L	VLAN Filter 5 Low	4A _H	
VF6L	VLAN Filter 6 Low	4C _H	
VF7L	VLAN Filter 7 Low	4E _H	
VF8L	VLAN Filter 8 Low	50 _H	
VF9L	VLAN Filter 9 Low	52 _H	
VF10L	VLAN Filter 10 Low	54 _H	
VF11L	VLAN Filter 11 Low	56 _H	
VF12L	VLAN Filter 12 Low	58 _H	
VF13L	VLAN Filter 13 Low	5A _H	
VF14L	VLAN Filter 14 Low	5C _H	
VF15L	VLAN Filter 15 Low	5E _H	

VLAN Filter 0 High

VF0H	Offset	Reset Value
VLAN Filter 0 High	41_H	8001_H

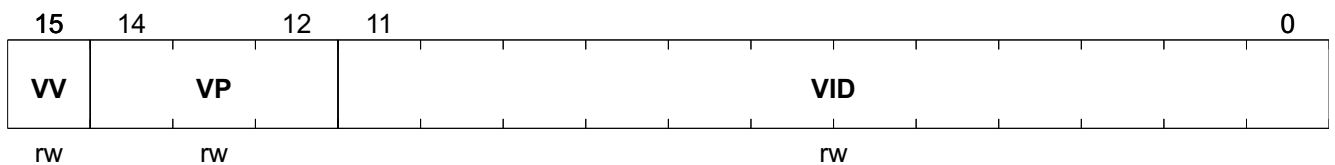

Field	Bits	Type	Description
VV	15	rw	VLAN_Valid 0 _B VLAN filter is not valid 1 _B VLAN Filter is valid
VP	14:12	rw	VLAN PRI It indicates the VLAN priority associated with VID.
VID	11:0	rw	VID It indicates the VLAN ID that is associated with FID, Tagged Member, Member and VLAN PRI.

Similar Registers

All VFxH registers have the same structure and characteristics, see [VF0H](#).
The offset addresses of the other VFxH registers are listed in [Table 42](#).

Table 42 VFxH Registers

Register Short Name	Register Long Name	Offset Address	Page Number
VF1H	VLAN Filter 1 High	43 _H	
VF2H	VLAN Filter 2 High	45 _H	
VF3H	VLAN Filter 3 High	47 _H	

16 Bits Mode Registers Description

Table 42 VFxH Registers (cont'd)

Register Short Name	Register Long Name	Offset Address	Page Number
VF4H	VLAN Filter 4 High	49 _H	
VF5H	VLAN Filter 5 High	4B _H	
VF6H	VLAN Filter 6 High	4D _H	
VF7H	VLAN Filter 7 High	4F _H	
VF8H	VLAN Filter 8 High	51 _H	
VF9H	VLAN Filter 9 High	53 _H	
VF10H	VLAN Filter 10 High	55 _H	
VF11H	VLAN Filter 11 High	57 _H	
VF12H	VLAN Filter 12 High	59 _H	
VF13H	VLAN Filter 13 High	5B _H	
VF14H	VLAN Filter 14 High	5D _H	
VF15H	VLAN Filter 15 High	5F _H	

Type Filter 0

TF0	Offset	Reset Value
Type Filter 0	60_H	0000_H

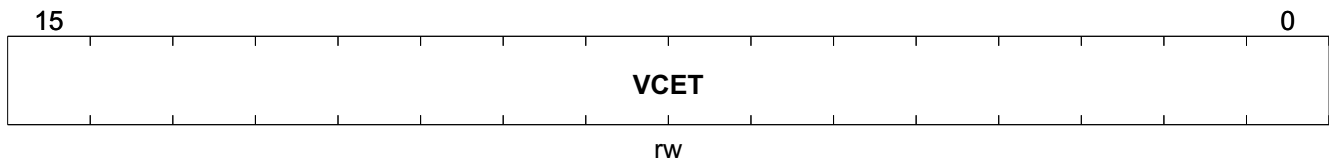

Field	Bits	Type	Description
VCET	15:0	rw	Value Compared with Ether-Type

Similar Registers

All TFx registers have the same structure and characteristics, see [TF0](#).
The offset addresses of the other TFx registers are listed in [Table 43](#).

Table 43 TFx Registers

Register Short Name	Register Long Name	Offset Address	Page Number
TF1	Type Filter 1	61 _H	
TF2	Type Filter 2	62 _H	
TF3	Type Filter 3	63 _H	
TF4	Type Filter 4	64 _H	
TF5	Type Filter 5	65 _H	
TF6	Type Filter 6	66 _H	
TF7	Type Filter 7	67 _H	

16 Bits Mode Registers Description

Protocol Filter 1 and 0

PF_1_0 **Offset**
Protocol Filter 1 and 0 **68_H** **Reset Value**
0000_H

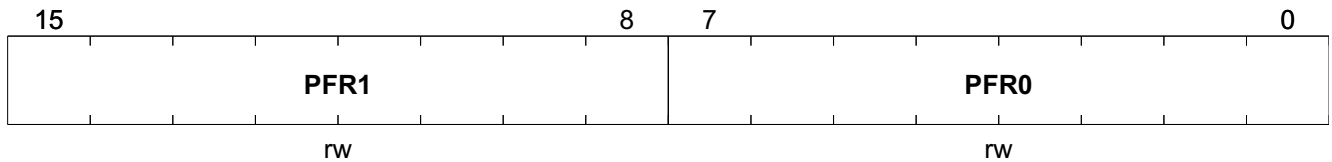

Field	Bits	Type	Description
PFR1	15:8	rw	Value Compared with Protocol in IP Header (Protocol Filter 1, 3, 5, 7)
PFR0	7:0	rw	Value Compared with Protocol in IP Header (Protocol Filter 0, 2, 4, 6)

Similar Registers

All PFx registers have the same structure and characteristics, see [PF_1_0](#).
 The offset addresses of the other PFx registers are listed in [Table 44](#).

Table 44 PFx Registers

Register Short Name	Register Long Name	Offset Address	Page Number
PF_3_2	Protocol Filter 3 and 2	68 _H	
PF_5_4	Protocol Filter 5 and 4	69 _H	
PF_7_6	Protocol Filter 7 and 6	6A _H	

TCP/UDP Filter 0

TUF0 **Offset**
TCP/UDP Filter 0 **8C_H** **Reset Value**
0000_H

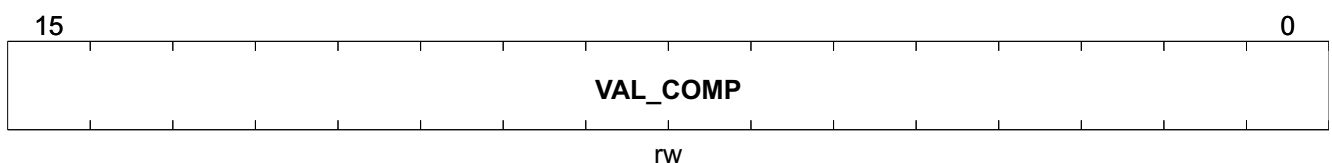

Field	Bits	Type	Description
VAL_COMP	15:0	rw	Value Compared with the Destination Port Number in the TCP/UDP Header

Similar Registers

All TUFx registers have the same structure and characteristics, see [TUF0](#).
The offset addresses of the other TUFx registers are listed in [Table 47](#).

Table 45 TUFx Registers

Register Short Name	Register Long Name	Offset Address	Page Number
TUF1	TCP/UDP Filter 1	8D _H	
TUF2	TCP/UDP Filter 2	8E _H	
TUF3	TCP/UDP Filter 3	8F _H	
TUF4	TCP/UDP Filter 4	90 _H	
TUF5	TCP/UDP Filter 5	91 _H	
TUF6	TCP/UDP Filter 6	92 _H	
TUF7	TCP/UDP Filter 7	93 _H	

Type Filter Action

TFA **Offset**
Type Filter Action **94_H** **Reset Value**
0000_H

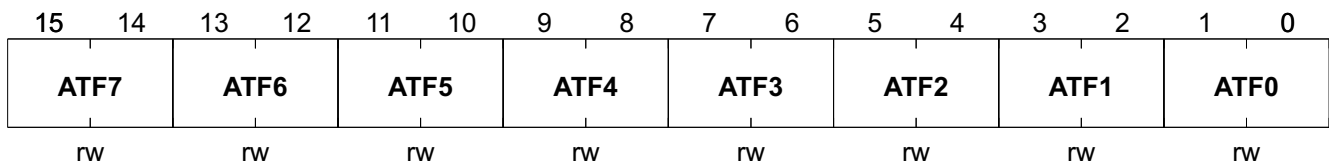

Field	Bits	Type	Description
ATF7	15:14	rw	Action for Type Filter 7 See register 0094 _H , ATF0 for more detail.
ATF6	13:12	rw	Action for Type Filter 6 See register 0094 _H , ATF0 for more detail.
ATF5	11:10	rw	Action for Type Filter 5 See register 0094 _H , ATF0 for more detail.
ATF4	9:8	rw	Action for Type Filter 4 See register 0094 _H , ATF0 for more detail.
ATF3	7:6	rw	Action for Type Filter 3 See register 0094 _H , ATF0 for more detail.
ATF2	5:4	rw	Action for Type Filter 2 See register 0094 _H , ATF0 for more detail.
ATF1	3:2	rw	Action for Type Filter 1 See register 0094 _H , ATF0 for more detail.

16 Bits Mode Registers Description

Field	Bits	Type	Description
ATF0	1:0	rw	Action for Type Filter 0 00 _B Type Portmap is Default Output Ports 01 _B Type Portmap is 000000 _B 10 _B Type Portmap is the CPU port if the incoming port is not the CPU port. But if the incoming port is the CPU port, then Type Portmap contains Default Output Ports , excluding the CPU port 11 _B Type Portmap contains Default Output Ports , excluding the CPU port

Protocol Filter Action

PFA	Offset	Reset Value
Protocol Filter Action	95 _H	0000 _H

15	14	13	12	11	10	9	8	7	6	5	4	3	2	1	0
APF7		APF6		APF5		APF4		APF3		APF2		APF1		APF0	
rw		rw		rw		rw		rw		rw		rw		rw	

Field	Bits	Type	Description
APF7	15:14	rw	Action for Protocol Filter 7 See register 0095 _H , APF0 for more detail.
APF6	13:12	rw	Action for Protocol Filter 6 See register 0095 _H , APF0 for more detail.
APF5	11:10	rw	Action for Protocol Filter 5 See register 0095 _H , APF0 for more detail.
APF4	9:8	rw	Action for Protocol Filter 4 See register 0095 _H , APF0 for more detail.
APF3	7:6	rw	Action for Protocol Filter 3 See register 0095 _H , APF0 for more detail.
APF2	5:4	rw	Action for Protocol Filter 2 See register 0095 _H , APF0 for more detail.
APF1	3:2	rw	Action for Protocol Filter 1 See register 0095 _H , APF0 for more detail.
APF0	1:0	rw	Action for Protocol Filter 0 00 _B Protocol Portmap is Default Output Ports 01 _B Protocol Portmap is 000000 _B 10 _B Protocol Portmap is the CPU port if the incoming port is not the CPU port. But if the incoming port is the CPU port, then Type Portmap contains Default Output Ports , excluding the CPU port 11 _B Protocol Portmap contains Default Output Ports , excluding the CPU port

16 Bits Mode Registers Description

TCP/UDP Action 0

TUA0 **Offset**
TCP/UDP Action 0 **96_H** **Reset Value**
0000_H

15	14	13	12	11	10	9	8	7	6	5	4	3	2	1	0
ATUF3		TUPF3		ATUF2		TUPF2		ATUF1		TUPF1		ATUF0		TUPF0	
rw		rw		rw		rw		rw		rw		rw		rw	

Field	Bits	Type	Description
ATUF3	15:14	rw	Action for TCP/UDP Filter 3. See register 0096 _H , ATUF0 for more detail.
TUPF3	13:12	rw	TCP/UDP PRI for TCP/UDP Filter 3 See register 0096 _H , TUPF0 for more detail.
ATUF2	11:10	rw	Action for TCP/UDP Filter 2 See register 0096 _H , ATUF0 for more detail.
TUPF2	9:8	rw	TCP/UDP PRI for TCP/UDP Filter 2 See register 0096 _H , TUPF0 for more detail.
ATUF1	7:6	rw	Action for TCP/UDP Filter 1 See register 0096 _H , ATUF0 for more detail.
TUPF1	5:4	rw	TCP/UDP PRI for TCP/UDP Filter 1 See register 0096 _H , TUPF0 for more detail.
ATUF0	3:2	rw	Action for TCP/UDP Filter 0 00 _B Protocol Portmap is Default Output Ports 01 _B Protocol Portmap is 000000 _B 10 _B Protocol Portmap is the CPU port if the incoming port is not the CPU port. But if the incoming port is the CPU port, then Type Portmap contains Default Output Ports , excluding the CPU port 11 _B Protocol Portmap contains Default Output Ports , excluding the CPU port
TUPF0	1:0	rw	TCP/UDP PRI for TCP/UDP Filter 0 00 _B Queue 0 01 _B Queue 1 10 _B Queue 2 11 _B Queue 3

TCP/UDP Action 1

TUA1 **Offset**
TCP/UDP Action 1 **97_H** **Reset Value**
0000_H

16 Bits Mode Registers Description

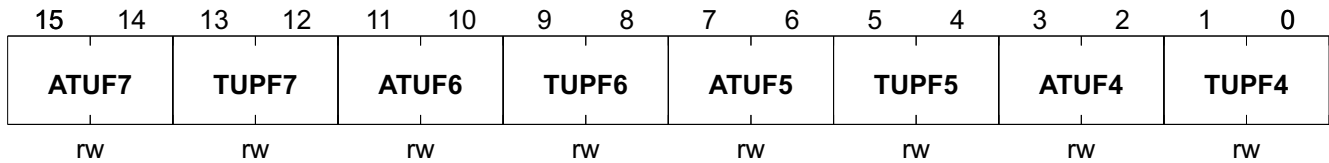

Field	Bits	Type	Description
ATUF7	15:14	rw	Action for TCP/UDP Filter 7 See register 0096 _H , ATUF0 for more detail.
TUPF7	13:12	rw	TCP/UDP PRI for TCP/UDP Filter 7 See register 0096 _H , TUPF0 for more detail.
ATUF6	11:10	rw	Action for TCP/UDP Filter 6 See register 0096 _H , ATUF0 for more detail.
TUPF6	9:8	rw	TCP/UDP PRI for TCP/UDP Filter 6 See register 0096 _H , TUPF0 for more detail.
ATUF5	7:6	rw	Action for TCP/UDP Filter 5 See register 0096 _H , ATUF0 for more detail.
TUPF5	5:4	rw	TCP/UDP PRI for TCP/UDP Filter 5 See register 0096 _H , TUPF0 for more detail.
ATUF4	3:2	rw	Action for TCP/UDP Filter 4 See register 0096 _H , ATUF0 for more detail.
TUPF4	1:0	rw	TCP/UDP PRI for TCP/UDP Filter 4 See register 0096 _H , TUPF0 for more detail.

TCP/UDP Action 2

TUA2	Offset	Reset Value
TCP/UDP Action 2	98_H	0000_H

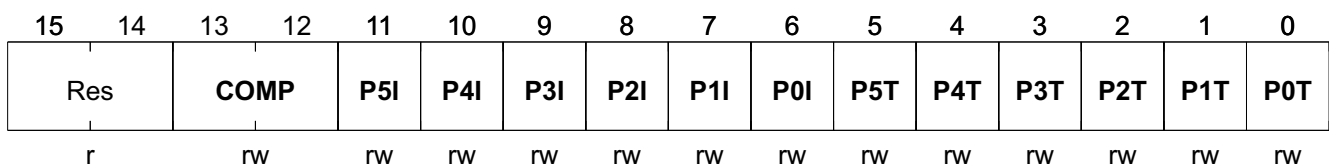

Field	Bits	Type	Description
Res	15:14	r	Reserved
COMP	13:12	rw	Compare TCP/UDP Source Port or Destination Port 00 _B Do not Compare 01 _B Compare Destination Port 10 _B Compare Source Port 11 _B Compare Destination Port or Source Port
P5I	11	rw	Port 5 IP over TCP/UDP 0 _B Use TCP/UDP field when packets contain both TCP/UDP and IP 1 _B Use IP field when packets contain both TCP/UDP and IP

16 Bits Mode Registers Description

Field	Bits	Type	Description
P4I	10	rw	Port 4 IP over TCP/UDP 0 _B Use TCP/UDP field when packets contain both TCP/UDP and IP 1 _B Use IP field when packets contain both TCP/UDP and IP
P3I	9	rw	Port 3 IP over TCP/UDP 0 _B Use TCP/UDP field when packets contain both TCP/UDP and IP 1 _B Use IP field when packets contain both TCP/UDP and IP
P2I	8	rw	Port 2 IP over TCP/UDP 0 _B Use TCP/UDP field when packets contain both TCP/UDP and IP 1 _B Use IP field when packets contain both TCP/UDP and IP
P1I	7	rw	Port 1 IP over TCP/UDP 0 _B Use TCP/UDP field when packets contain both TCP/UDP and IP 1 _B Use IP field when packets contain both TCP/UDP and IP
P0I	6	rw	Port 0 IP over TCP/UDP 0 _B Use TCP/UDP field when packets contain both TCP/UDP and IP 1 _B Use IP field when packets contain both TCP/UDP and IP
P5T	5	rw	Port 5 TCP/UDP PRIEN 0 _B Do not use TCP/UDP priority 1 _B Use TCP/UDP priority
P4T	4	rw	Port 4 TCP/UDP PRIEN 0 _B Do not use TCP/UDP priority 1 _B Use TCP/UDP priority
P3T	3	rw	Port 3 TCP/UDP PRIEN 0 _B Do not use TCP/UDP priority 1 _B Use TCP/UDP priority
P2T	2	rw	Port 2 TCP/UDP PRIEN 0 _B Do not use TCP/UDP priority 1 _B Use TCP/UDP priority
P1T	1	rw	Port 1 TCP/UDP PRIEN 0 _B Do not use TCP/UDP priority 1 _B Use TCP/UDP priority
P0T	0	rw	Port 0 TCP/UDP PRIEN 0 _B Do not use TCP/UDP priority 1 _B Use TCP/UDP priority

Interrupt Enable Register

IE	Offset	Reset Value
Interrupt Enable Register	9A _H	0000 _H

15	9	8	7	2	1	0
Res		LTAD IE	PSIE		COIE	PSIE
r		rw	rw		rw	rw

16 Bits Mode Registers Description

Field	Bits	Type	Description
Res	15:9	r	Reserved
LTADIE	8	rw	Leaning Table Access Done Interrupt Enable 0 _B Interrupt disable 1 _B Interrupt enable
PSIE	7:2	rw	Port Security Interrupt Enable It's a per port setting 0 _B Interrupt disable 1 _B Interrupt enable
COIE	1	rw	Counter Overflow Interrupt Enable 0 _B Interrupt disable 1 _B Interrupt enable
PSIE	0	rw	Port Status Interrupt Enable 0 _B Interrupt disable 1 _B Interrupt enable

Interrupt Status Register

IS **Offset** **Reset Value**
Interrupt Status Register **9B_H** **0000_H**

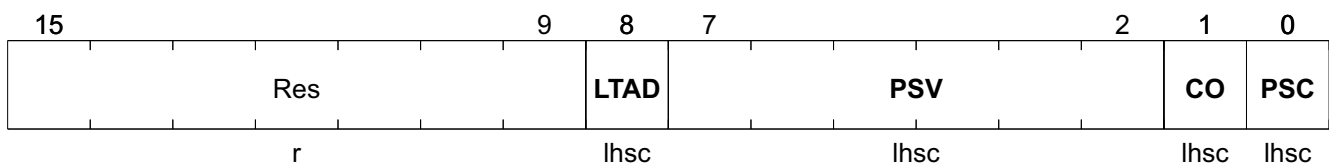

Field	Bits	Type	Description
Res	15:9	r	Reserved
LTAD	8	lhsc	Leaning Table Access Done 0 _B Access does not end 1 _B Access end
PSV	7:2	lhsc	Port Security Violation It's a per port setting 0 _B Security did not violate 1 _B Security violated
CO	1	lhsc	Counter Overflow 0 _B Overflow did not happen 1 _B Overflow happened for any of the counters
PSC	0	lhsc	Port Status Change 0 _B No status (link, speed, duplex, flow control) changed for any port 1 _B Status changed for any of 6 ports

16 Bits Mode Registers Description

Field	Bits	Type	Description
Res	15:12	ro	Reserved
P1FCS	11	ro	Port 1 Flow Control Status 0 _B Port 1 disables the Full Flow Control/Half Back Pressure Function 1 _B Port 1 enabled the Full Flow Control/Half Back Pressure Function
P1DS	10	ro	Port 1 Duplex Status 0 _B Port 1 operates in the Half Duplex 1 _B Port 1 operates in the Full Duplex
P1SS	9	ro	Port 1 Speed Status 0 _B Port 1 operates in the 10M 1 _B Port 1 operates in the 100M
P1LS	8	ro	Port 1 Link Status 0 _B Port 1 links down 1 _B Port 1 links up
Res	7:4	ro	Reserved
P0FCS	3	ro	Port 0 Flow Control Status 0 _B Port 0 disables the Full Flow Control/Half Back Pressure Function 1 _B Port 0 enabled the Full Flow Control/Half Back Pressure Function
P0DS	2	ro	Port 0 Duplex Status 0 _B Port 0 operates in the Half Duplex 1 _B Port 0 operates in the Full Duplex
P0SS	1	ro	Port 0 Speed Status 0 _B Port 0 operates in the 10M 1 _B Port 0 operates in the 100M
P0LS	0	ro	Port 0 Link Status 0 _B Port 0 links down 1 _B Port 0 links up

Port Status 1

PS1 **Offset** **Reset Value**
Port Status 1 **A3_H** **0000_H**

	15	14	13	12	11	10	9	8	7		4	3	2	1	0
	P4FCS	P4DS	P4SS	P4LS	P3FCS	P3DS	P3SS	P3LS		Res		P2FCS	P2DS	P2SS	P2LS
	ro	ro	ro	ro	ro	ro	ro	ro		ro		ro	ro	ro	ro

Field	Bits	Type	Description
P4FCS	15	ro	Port 4 Flow Control Status 0 _B Port 4 disables the Full Flow Control/Half Back Pressure Function 1 _B Port 4 enabled the Full Flow Control/Half Back Pressure Function

16 Bits Mode Registers Description

Field	Bits	Type	Description
P4DS	14	ro	Port 4 Duplex Status 0 _B Port 4 operates in the Half Duplex 1 _B Port 4 operates in the Full Duplex
P4SS	13	ro	Port 4 Speed Status 0 _B Port 4 operates in the 10M 1 _B Port 4 operates in the 100M
P4LS	12	ro	Port 4 Link Status 0 _B Port 4 links down 1 _B Port 4 links up
P3FCS	11	ro	Port 3 Flow Control Status 0 _B Port 3 disables the Full Flow Control/Half Back Pressure Function 1 _B Port 3 enabled the Full Flow Control/Half Back Pressure Function
P3DS	10	ro	Port 3 Duplex Status 0 _B Port 3 operates in the Half Duplex 1 _B Port 3 operates in the Full Duplex
P3SS	9	ro	Port 3 Speed Status 0 _B Port 3 operates in the 10M 1 _B Port 3 operates in the 100M
P3LS	8	ro	Port 3 Link Status 0 _B Port 3 links down 1 _B Port 3 links up.
Res	7:4	ro	Reserved
P2FCS	3	ro	Port 2 Flow Control Status 0 _B Port 2 disables the Full Flow Control/Half Back Pressure Function 1 _B Port 2 enabled the Full Flow Control/Half Back Pressure Function
P2DS	2	ro	Port 2 Duplex Status 0 _B Port 2 operates in the Half Duplex 1 _B Port 2 operates in the Full Duplex
P2SS	1	ro	Port 2 Speed Status 0 _B Port 2 operates in the 10M 1 _B Port 2 operates in the 100M
P2LS	0	ro	Port 2 Link Status 0 _B Port 2 links down 1 _B Port 2 links up

Port Status 2

PS2	Offset	Reset Value
Port Status 2	A4_H	0000_H

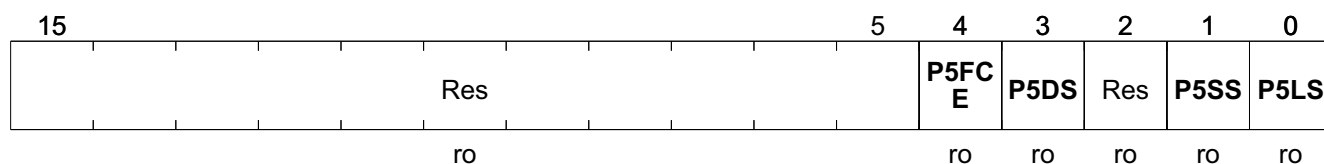

16 Bits Mode Registers Description

Field	Bits	Type	Description
Res	15:5	ro	Reserved
P5FCE	4	ro	Port 5 Flow Control Enable 0 _B Port 5 disables the Full Flow Control/Half Back Pressure Function 1 _B Port 5 enabled the Full Flow Control/Half Back Pressure Function
P5DS	3	ro	Port 5 Duplex Status 0 _B Port 5 operates in the Half Duplex 1 _B Port 5 operates in the Full Duplex
Res	2	ro	Reserved
P5SS	1	ro	Port 5 Speed Status 0 _B Port 5 operates in the 10M 1 _B Port 5 operates in the 100M
P5LS	0	ro	Port 5 Link Status 0 _B Port 5 links down 1 _B Port 5 links up

Counter Low 0

CL0	Offset	Reset Value
Port 0 Receive Packet Counter Low	A8_H	0000_H

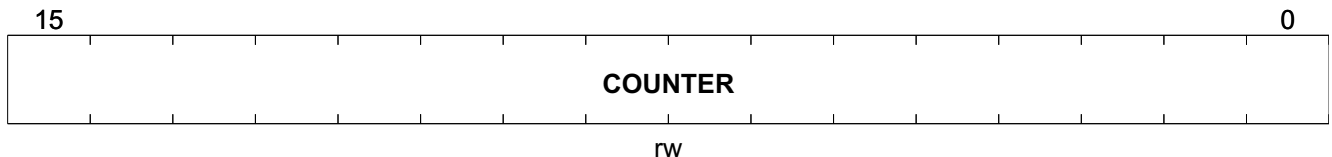

Field	Bits	Type	Description
COUNTER	15:0	rw	Counter[15:0]

Similar Registers

All CLx registers have the same structure and characteristics, see [CL0](#).
The offset addresses of the other CLx registers are listed in [Table 46](#).

Table 46 CLx Registers

Register Short Name	Register Long Name	Offset Address	Page Number
CL1	Port 1 Receive Packet Counter Low	AC _H	
CL2	Port 2 Receive Packet Counter Low	B0 _H	
CL3	Port 3 Receive Packet Counter Low	B4 _H	
CL4	Port 4 Receive Packet Counter Low	B6 _H	
CL5	Port 5 Receive Packet Counter Low	B8 _H	
CL6	Port 0 Receive Packet Byte Count Low	BA _H	
CL7	Port 1 Receive Packet Byte Count Low	BE _H	

16 Bits Mode Registers Description

Table 46 CLx Registers (cont'd)

Register Short Name	Register Long Name	Offset Address	Page Number
CL8	Port 2 Receive Packet Byte Count Low	C2 _H	
CL9	Port 3 Receive Packet Byte Count Low	C6 _H	
CL10	Port 4 Receive Packet Byte Count Low	C8 _H	
CL11	Port 5 Receive Packet Byte Count Low	CA _H	
CL12	Port 0 Transmit Packet Count Low	CC _H	
CL13	Port 1 Transmit Packet Count Low	D0 _H	
CL14	Port 2 Transmit Packet Count Low	D4 _H	
CL15	Port 3 Transmit Packet Count Low	D8 _H	
CL16	Port 4 Transmit Packet Count Low	DA _H	
CL17	Port 5 Transmit Packet Count Low	DC _H	
CL18	Port 0 Transmit Packet Byte Count Low	DE _H	
CL19	Port 1 Transmit Packet Byte Count Low	E2 _H	
CL20	Port 2 Transmit Packet Byte Count Low	E6 _H	
CL21	Port 3 Transmit Packet Byte Count Low	EA _H	
CL22	Port 4 Transmit Packet Byte Count Low	EC _H	
CL23	Port 5 Transmit Packet Byte Count Low	EE _H	
CL24	Port 0 Collision Count Low	F0 _H	
CL25	Port 1 Collision Count Low	F4 _H	
CL26	Port 2 Collision Count Low	F8 _H	
CL27	Port 3 Collision Count Low	FC _H	
CL28	Port 4 Collision Count Low	FE _H	
CL29	Port 5 Collision Count Low	100 _H	
CL30	Port 0 Error Count Low	102 _H	
CL31	Port 1 Error Count Low	106 _H	
CL32	Port 2 Error Count Low	10A _H	
CL33	Port 3 Error Count Low	10E _H	
CL34	Port 4 Error Count Low	110 _H	
CL35	Port 5 Error Count Low	112 _H	

Counter High 0

CH0	Offset	Reset Value
Port 0 Receive Packet Counter High	A9_H	0000_H

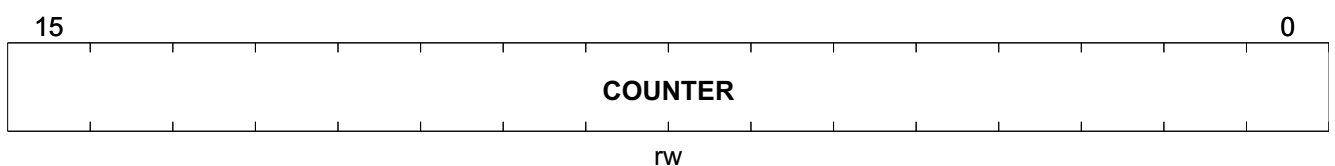

16 Bits Mode Registers Description

Field	Bits	Type	Description
COUNTER	15:0	rw	Counter[31:16]

Similar Registers

All CHx registers have the same structure and characteristics, see [CH0](#).
The offset addresses of the other CLH registers are listed in [Table 47](#).

Table 47 CHx Registers

Register Short Name	Register Long Name	Offset Address	Page Number
CH1	Port 1 Receive Packet Counter High	AD _H	
CH2	Port 2 Receive Packet Counter High	B1 _H	
CH3	Port 3 Receive Packet Counter High	B5 _H	
CH4	Port 4 Receive Packet Counter High	B7 _H	
CH5	Port 5 Receive Packet Counter High	B9 _H	
CH6	Port 0 Receive Packet Byte Count High	BB _H	
CH7	Port 1 Receive Packet Byte Count High	BF _H	
CH8	Port 2 Receive Packet Byte Count High	C3 _H	
CH9	Port 3 Receive Packet Byte Count High	C7 _H	
CH10	Port 4 Receive Packet Byte Count High	C9 _H	
CH11	Port 5 Receive Packet Byte Count High	CB _H	
CH12	Port 0 Transmit Packet Count High	CD _H	
CH13	Port 1 Transmit Packet Count High	D1 _H	
CH14	Port 2 Transmit Packet Count High	D5 _H	
CH15	Port 3 Transmit Packet Count High	D9 _H	
CH16	Port 4 Transmit Packet Count High	DB _H	
CH17	Port 5 Transmit Packet Count High	DD _H	
CH18	Port 0 Transmit Packet Byte Count High	DF _H	
CH19	Port 1 Transmit Packet Byte Count High	E3 _H	
CH20	Port 2 Transmit Packet Byte Count High	E7 _H	
CH21	Port 3 Transmit Packet Byte Count High	EB _H	
CH22	Port 4 Transmit Packet Byte Count High	ED _H	
CH23	Port 5 Transmit Packet Byte Count High	EF _H	
CH24	Port 0 Collision Count High	F1 _H	
CH25	Port 1 Collision Count High	F5 _H	
CH26	Port 2 Collision Count High	F9 _H	
CH27	Port 3 Collision Count High	FD _H	
CH28	Port 4 Collision Count High	FF _H	
CH29	Port 5 Collision Count High	101 _H	
CH30	Port 0 Error Count High	103 _H	
CH31	Port 1 Error Count High	107 _H	
CH32	Port 2 Error Count High	10B _H	
CH33	Port 3 Error Count High	10F _H	

16 Bits Mode Registers Description

Table 47 CHx Registers (cont'd)

Register Short Name	Register Long Name	Offset Address	Page Number
CH34	Port 4 Error Count High	111 _H	
CH35	Port 5 Error Count High	113 _H	

Over-Flow Flag 0

OFF0 **Offset** **Reset Value**
Over-Flow Flag 0 **114_H** **0000_H**

15	14	13	12	11	10	9	8	7	6	5	4	3	2	1	0
P3_B C	Res	P2_B C	Res	P1_B C	Res	P0_B C	P5_C	P4_C	P3_C	Res	P2_C	Res	P1_C	Res	P0_C
lhsc	ro	lhsc	ro	lhsc	ro	lhsc	lhsc	lhsc	lhsc	ro	lhsc	ro	lhsc	ro	lhsc

Field	Bits	Type	Description
P3_BC	15	lhsc	Overflow of Port 3 Receive Packet Byte Count 0 _B No overflow 1 _B Overflow
Res	14	ro	Reserved
P2_BC	13	lhsc	Overflow of Port 2 Receive Packet Byte Count 0 _B No overflow 1 _B Overflow
Res	12	ro	Reserved
P1_BC	11	lhsc	Overflow of Port 1 Receive Packet Byte Count 0 _B No overflow 1 _B Overflow
Res	10	ro	Reserved
P0_BC	9	lhsc	Overflow of Port 0 Receive Packet Byte Count 0 _B No overflow 1 _B Overflow
P5_C	8	lhsc	Overflow of Port 5 Receive Packet Count 0 _B No overflow 1 _B Overflow
P4_C	7	lhsc	Overflow of Port 4 Receive Packet Count 0 _B No overflow 1 _B Overflow
P3_C	6	lhsc	Overflow of Port 3 Receive Packet Count 0 _B No overflow 1 _B Overflow
Res	5	ro	Reserved
P2_C	4	lhsc	Overflow of Port 2 Receive Packet Count 0 _B No overflow 1 _B Overflow

16 Bits Mode Registers Description

Field	Bits	Type	Description
Res	3	ro	Reserved
P1_C	2	lhsc	Overflow of Port 1 Receive Packet Count 0 _B No overflow 1 _B Overflow
Res	1	ro	Reserved
P0_C	0	lhsc	Overflow of Port 0 Receive Packet Count 0 _B No overflow 1 _B Overflow

Over-Flow Flag 1

OFF1	Offset	Reset Value
Over-Flow Flag 1	115_H	0000_H

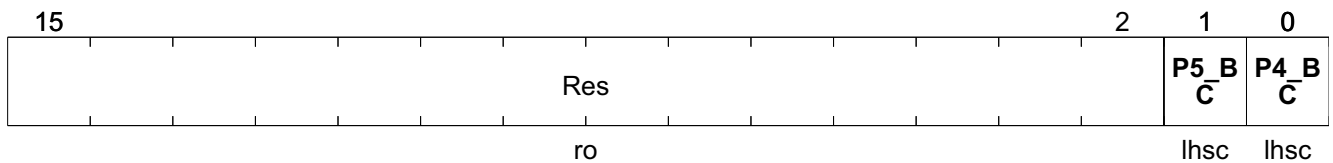

Field	Bits	Type	Description
Res	15:2	ro	Reserved
P5_BC	1	lhsc	Overflow of Port 5 Receive Packet Byte Count 0 _B No overflow 1 _B Overflow
P4_BC	0	lhsc	Overflow of Port 4 Receive Packet Byte Count 0 _B No overflow 1 _B Overflow

Over-Flow Flag 2

OFF2	Offset	Reset Value
Over-Flow Flag 2	116_H	0000_H

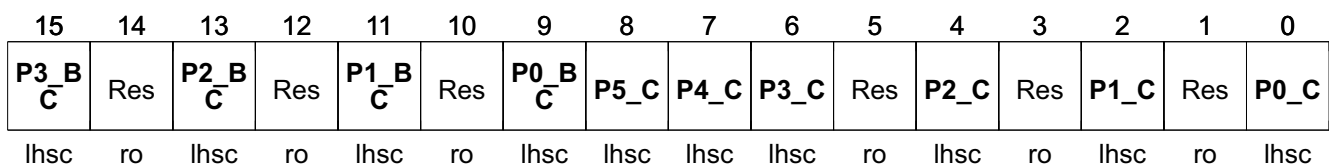

16 Bits Mode Registers Description

Field	Bits	Type	Description
P3_BC	15	lhsc	Overflow of Port 3 Transmit Packet Byte Count 0 _B No overflow 1 _B Overflow
Res	14	ro	Reserved
P2_BC	13	lhsc	Overflow of Port 2 Transmit Packet Byte Count 0 _B No overflow 1 _B Overflow
Res	12	ro	Reserved
P1_BC	11	lhsc	Overflow of Port 1 Transmit Packet Byte Count 0 _B No overflow 1 _B Overflow
Res	10	ro	Reserved
P0_BC	9	lhsc	Overflow of Port 0 Transmit Packet Byte Count 0 _B No overflow 1 _B Overflow
P5_C	8	lhsc	Overflow of Port 5 Transmit Packet Count 0 _B No overflow 1 _B Overflow
P4_C	7	lhsc	Overflow of Port 4 Transmit Packet Count 0 _B No overflow 1 _B Overflow
P3_C	6	lhsc	Overflow of Port 3 Transmit Packet Count 0 _B No overflow 1 _B Overflow
Res	5	ro	Reserved
P2_C	4	lhsc	Overflow of Port 2 Transmit Packet Count 0 _B No overflow 1 _B Overflow
Res	3	ro	Reserved
P1_C	2	lhsc	Overflow of Port 1 Transmit Packet Count 0 _B No overflow 1 _B Overflow
Res	1	ro	Reserved
P0_C	0	lhsc	Overflow of Port 0 Transmit Packet Count 0 _B No overflow 1 _B Overflow

Over-Flow Flag 3

OFF3	Offset	Reset Value
Over-Flow Flag 3	117_H	0000_H

16 Bits Mode Registers Description



Field	Bits	Type	Description
Res	15:2	ro	Reserved
P5_BC	1	lhsc	Overflow of Port 5 Transmit Packet Byte Count 0 _B No overflow 1 _B Overflow
P4_BC	0	lhsc	Overflow of Port 4 Transmit Packet Byte Count 0 _B No overflow 1 _B Overflow

Over-Flow Flag 4

OFF4	Offset	Reset Value
Over-Flow Flag 4	118_H	0000_H

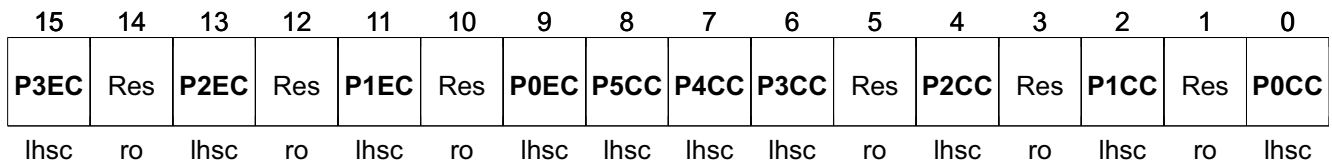

Field	Bits	Type	Description
P3EC	15	lhsc	Overflow of Port 3 Error Count 0 _B No overflow 1 _B Overflow
Res	14	ro	Reserved
P2EC	13	lhsc	Overflow of Port 2 Error Count 0 _B No overflow 1 _B Overflow
Res	12	ro	Reserved
P1EC	11	lhsc	Overflow of Port 1 Error Count 0 _B No overflow 1 _B Overflow
Res	10	ro	Reserved
P0EC	9	lhsc	Overflow of Port 0 Error Count 0 _B No overflow 1 _B Overflow
P5CC	8	lhsc	Overflow of Port 5 Collision Count 0 _B No overflow 1 _B Overflow

16 Bits Mode Registers Description

Field	Bits	Type	Description
P4CC	7	lhsc	Overflow of Port 4 Collision Count 0 _B No overflow 1 _B Overflow
P3CC	6	lhsc	Overflow of Port 3 Collision Count 0 _B No overflow 1 _B Overflow
Res	5	ro	Reserved
P2CC	4	lhsc	Overflow of Port 2 Collision Count 0 _B No overflow 1 _B Overflow
Res	3	ro	Reserved
P1CC	2	lhsc	Overflow of Port 1 Collision Count 0 _B No overflow 1 _B Overflow
Res	1	ro	Reserved
P0CC	0	lhsc	Overflow of Port 0 Collision Count 0 _B No overflow 1 _B Overflow

Over-Flow Flag 5

OFF5 **Offset**
Over-Flow Flag 5 **119_H** **Reset Value**
0000_H



Field	Bits	Type	Description
Res	15:2	ro	Reserved
P5EC	1	lhsc	Overflow of Port 5 Error Count 0 _B No overflow 1 _B Overflow
P4EC	0	lhsc	Overflow of Port 4 Error Count 0 _B No overflow 1 _B Overflow

Hardware Setting Low Register

HSL **Offset**
Hardware Setting Low Register **130_H** **Reset Value**
0000_H

16 Bits Mode Registers Description

15	14	13	12	11	10	9	8	7	6	5	4	3	2	1	0
H	BO	DAF	BP	DB	GM	RM	P4IT		GFC	P4FM	DC	CA		AC	AN
ro	ro	ro	ro	ro	ro	ro	ro	ro	ro	ro	ro	ro	ro	ro	ro

Field	Bits	Type	Description
H	15	ro	Resreved
BO	14	ro	Bond
DAF	13	ro	Disable ADM6996FC/FCX/FHX Function
BP	12	ro	BPEN
DB	11	ro	16/32 Bit Data Bus
GM	10	ro	GPSI Mode
RM	9	ro	RMII Mode
P4IT	8:7	ro	Port 4 Interface Type
GFC	6	ro	Global Flow Control
P4FM	5	ro	Port 4 Fiber Mode
DC	4	ro	Dual Color
CA	3:2	ro	Chip Address
AC	1	ro	Auto-Crossover
AN	0	ro	Auto-Negotiation

Hardware Setting High Register

HSH	Offset	Reset Value
Hardware Setting High Register	131 _H	0000 _H

15	10	9	8	7	6	5	4	3	2	1	0	
Res					LTBR	LLTB R	CTBR	HITB R	DBBR	P5M	P4M	CFG
ro					ro	ro	ro	ro	ro	ro	ro	ro

Field	Bits	Type	Description
Res	15:10	ro	Reserved
LTBR	9	ro	Learning Table Bist Result 0 _B Work 1 _B Do not Work
LLTBR	8	ro	Linklist Table Bist Result (Linklist Table does not do bist test in normal mode) 0 _B Work 1 _B Do not Work

16 Bits Mode Registers Description

Field	Bits	Type	Description
CTBR	7	ro	Control Table Bist Result 0 _B Work 1 _B Do not Work
HITBR	6	ro	Hardware IGMP Table Bist Result 0 _B Work 1 _B Do not Work
DBBR	5	ro	Data Buffer Bist Result 0 _B Work 1 _B Do not Work
P5M	4:3	ro	P5 Mode 00 _B GPSI 01 _B RMII 10 _B MII
P4M	2:1	ro	P4 Mode 00 _B Port 4 uses inner PHY 01 _B Port 4 uses MII 11 _B Port 4 isolated PHY
CFG	0	ro	CFG

Assign Option Register

AO **Offset**
Assign Option Register **135_H** **Reset Value**
0000_H

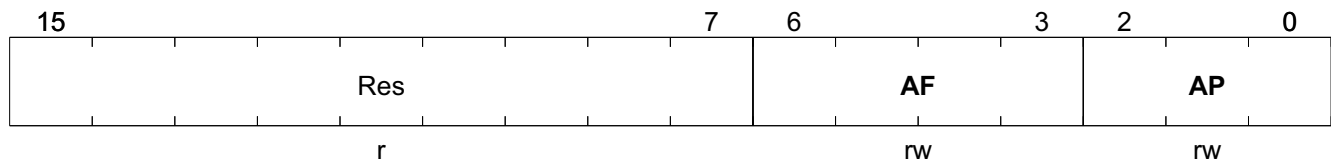

Field	Bits	Type	Description
Res	15:7	r	Reserved
AF	6:3	rw	Assign Fid It is used for assign lock FID.
AP	2:0	rw	Assign Port It is used for the port that the user wants to assign or for the monitor port.

Security Violation Port

SVP **Offset**
Security Violation Port **138_H** **Reset Value**
0000_H

16 Bits Mode Registers Description

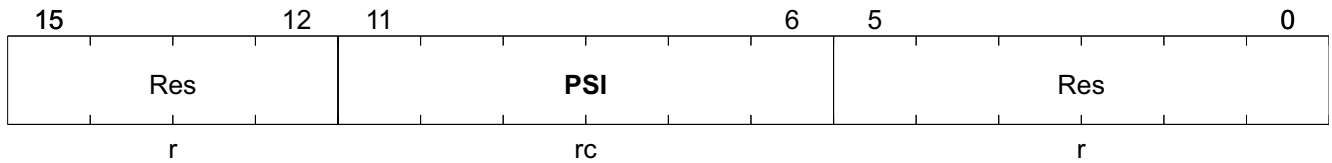

Field	Bits	Type	Description
Res	15:12	r	Reserved
PSI	11:6	rc	Port Source Intrusion 0 _B Source Intrusion did not happen 1 _B Source Intrusion happened
Res	5:0	r	Reserved

Security Status 0

SS0	Offset	Reset Value
Security Status 0	139_H	0000_H



Field	Bits	Type	Description
Res	15:12	r	Reserved
FL	11:6	r	First Lock 0 _B Port did not lock the address 1 _B Port locked the address
PL	5:0	r	Port Locked 0 _B Port did not close 1 _B Port closed because of source violation

Security Status 1

SS1	Offset	Reset Value
Security Status 1	13A_H	0000_H

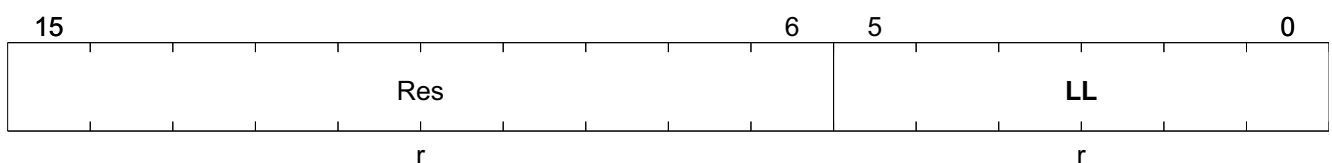

16 Bits Mode Registers Description

Field	Bits	Type	Description
Res	15:6	r	Reserved
LL	5:0	r	Link Lock 0 _B Link Lock did not happen 1 _B Link Lock happened

First Lock Address Search

FLAS	Offset	Reset Value
First Lock Address Search	13B _H	0000 _H

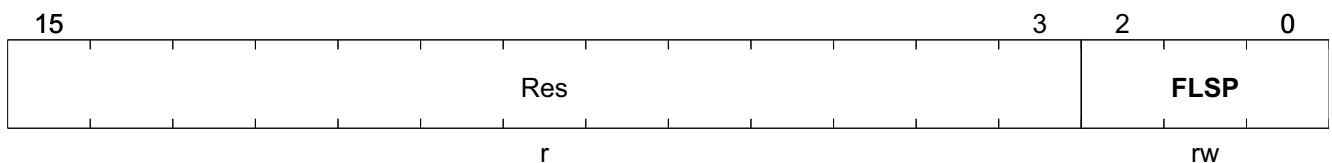

Field	Bits	Type	Description
Res	15:3	r	Reserved
FLSP	2:0	rw	First Lock Search Port Users could write this register to get the lock address and the lock FID (returned in the 13C _H , 13D _H , 13E _H , 13F _H) associated with the port. 000 _B Search the address and FID locked on the port 0 001 _B Search the address and FID locked on the port 1 010 _B Search the address and FID locked on the port 1 011 _B Search the address and FID locked on the port 1 100 _B Search the address and FID locked on the port 1 101 _B Search the address and FID locked on the port 1

First Lock Address [15:0]

FLA1	Offset	Reset Value
First Lock Address [15:0]	13C _H	0000 _H

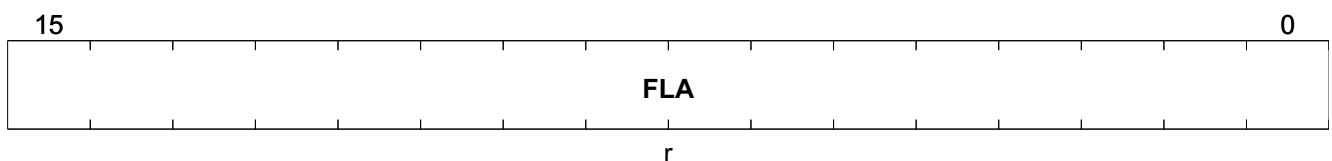

Field	Bits	Type	Description
FLA	15:0	r	First Lock Address [15:0]

16 Bits Mode Registers Description

First Lock Address [31:16]

FLA2	Offset	Reset Value
First Lock Address [31:16]	13D _H	0000 _H

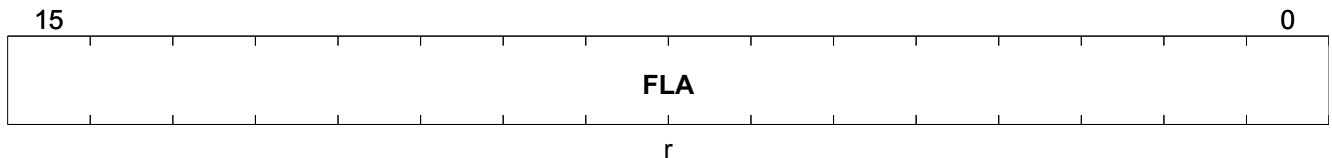

Field	Bits	Type	Description
FLA	15:0	r	First Lock Address [31:16]

First Lock Address [47:32]

FLA3	Offset	Reset Value
First Lock Address [47:32]	13E _H	0000 _H

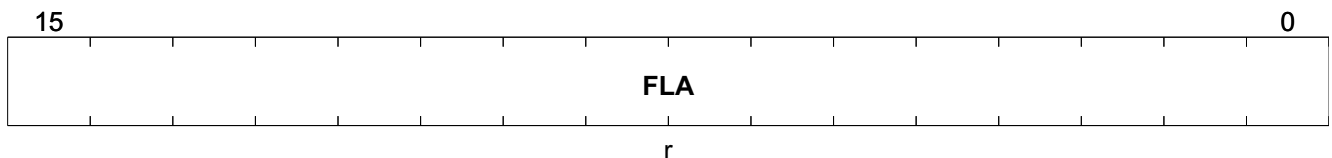

Field	Bits	Type	Description
FLA	15:0	r	First Lock Address [47:32]

First Lock FID

FLF	Offset	Reset Value
First Lock FID	13F _H	0000 _H

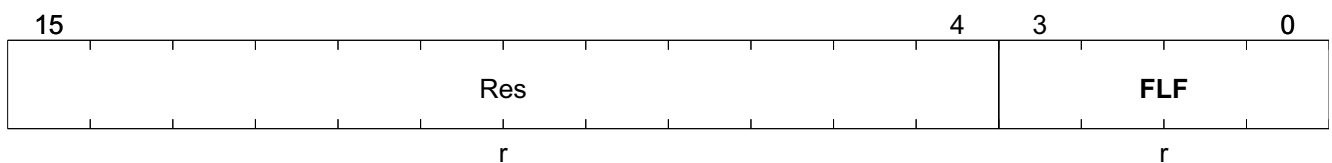

Field	Bits	Type	Description
Res	15:4	r	Reserved
FLF	3:0	r	First Lock FID

Counter Control Low Register

CCL	Offset	Reset Value
Counter Control Low Register	140_H	0000_H

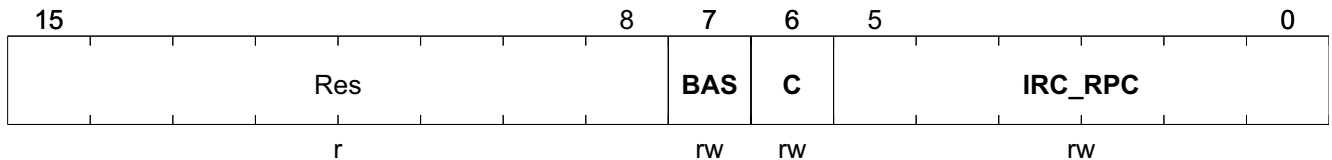

Field	Bits	Type	Description
Res	15:8	r	Reserved
BAS	7	rw	Busy/Access Start 0 _B The counter control is free 1 _B The counter control is busy, or users should write 1 _B into this bit to start the access when the engine is free
C	6	rw	Counter 0 _B Indirect Read Counter 1 _B Renew Port Counter
IRC_RPC	5:0	rw	Indirect Read Counter It means the counter address Renew Port Counter It means the counters on each port to renew

Counter Status Low Register

CSL	Offset	Reset Value
Counter Status Low Register	142_H	0000_H

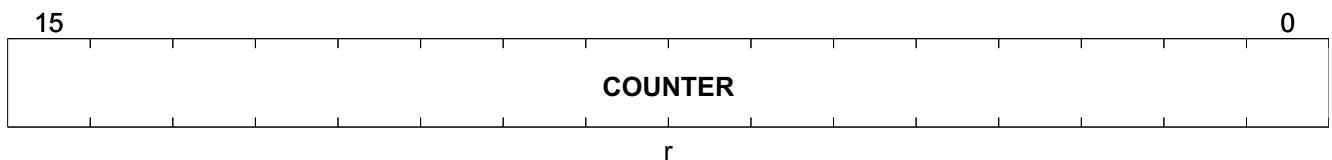

Field	Bits	Type	Description
COUNTER	15:0	r	Counter [15:0]

Counter Status High Register

CSH	Offset	Reset Value
Counter Status High Register	143_H	0000_H

16 Bits Mode Registers Description

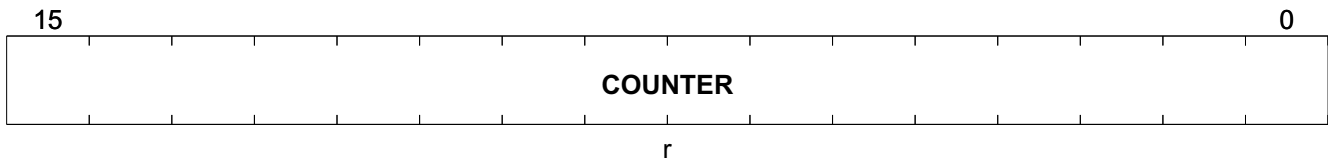

Field	Bits	Type	Description
COUNTER	15:0	r	Counter [31:16]

5.4 PHY Registers

PHY Control Register of Port 0

PHY_C0	Offset	Reset Value
PHY Control Register of Port 0	200 _H	3100 _H

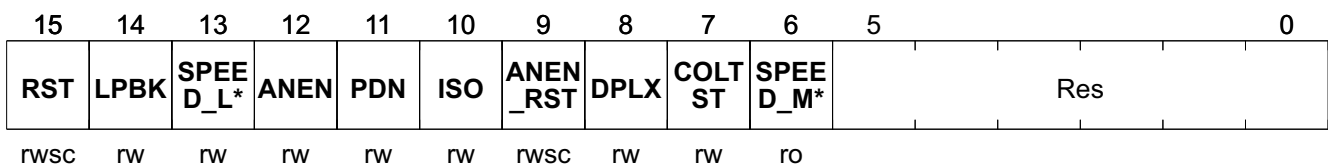

Field	Bits	Type	Description
RST	15	rwsc	RESET Setting this bit initiates the software reset function that resets the selected port, except for the phase-locked loop circuit. It will re-latch in all hardware configuration pin values. The software reset process takes $25 \leq t_s$ to complete. This bit, which is self-clearing, returns a value of 1 until the reset process is complete. 0_B Normal operation 1_B PHY Reset
LPBK	14	rw	Loop Back Enable This bit controls the PHY loopback operation that isolates the network transmitter outputs (TXP and TXN) and routes the MII transmit data to the MII receive data path. This function should only be used when auto negotiation is disabled (bit 12 = 0). The specific PHY (10Base-T or 100Base-X) used for this operation is determined by bits 12 and 13 of this register 0_B Disable Loopback mode 1_B Enable loopback mode

16 Bits Mode Registers Description

Field	Bits	Type	Description
SPEED_LSB	13	rw	<p>Speed Selection LSB, 0.6, 0.13 Link speed is selected by this bit or by auto negotiation if bit 12 of this register is set (in which case, the value of this bit is ignored). If it is fiber mode, 0.13 is always 1. Any write to this bit will have no effect.</p> <p>00_B 10 Mbit/s 01_B 100 Mbit/s 10_B 1000 Mbit/s 11_B Reserved</p>
ANEN	12	rw	<p>Auto Negotiation Enable This bit determines whether the link speed should set up by the auto negotiation process or not. It is set at power up or reset if the RECANEN pin detects a logic 1 input level in Twisted-Pair Mode. If it is set when fiber mode is configured, any write to this bit will be ignored .</p> <p>0_B Disable Auto negotiation process 1_B Enable auto negotiation process</p>
PDN	11	rw	<p>Power Down Enable Ored result with PI_PWRDN pin. Setting this bit high or asserting the PI_PWRDN puts the PHY into power down mode. During the power down mode, TXP/TXN and all LED outputs are tristated and the MII interfaces are isolated.</p> <p>0_B Normal Operation 1_B Power Down</p>
ISO	10	rw	<p>Isolate PHY from Network Setting this control bit isolates the part from the MII, with the exception of the serial management interface. When this bit is asserted, the PHY does not respond to TXD, TXEN and TXER inputs, and it presents a high impedance on its TXC, RXC, CRSDV, RXER, RXD , COL and CRS outputs.</p> <p>0_B Normal Operation 1_B Isolate PHY from MII</p>
ANEN_RST	9	rwsc	<p>Restart Auto Negotiation Setting this bit while auto negotiation is enabled forces a new auto negotiation process to start. This bit is self-clearing and returns to 0 after the auto negotiation process has commenced.</p> <p>0_B Normal Operation 1_B Restart Auto Negotiation Process</p>
DPLX	8	rw	<p>Duplex Mode If auto negotiation is disabled, this bit determines the duplex mode for the link.</p> <p>0_B Half Duplex mode 1_B Full Duplex mode</p>
COLTST	7	rw	<p>Collision Test When set, this bit will cause the COL signal of MII interface to be asserted in response to the assertion of TXEN.</p> <p>0_B Disable COL signal test 1_B Enable COL signal test</p>

16 Bits Mode Registers Description

Field	Bits	Type	Description
SPEED_MSB	6	ro	Speed Selection MSB Set to 0 all the time indicate that the PHY does not support 1000 Mbit/s function.

Similar Registers

All PHY_Cx registers have the same structure and characteristics, see [PHY_C0](#).
The offset addresses of the other PHY_Cx registers are listed in [Table 48](#).

Table 48 PHY_Cx Registers

Register Short Name	Register Long Name	Offset Address	Page Number
PHY_C1	PHY Control Register of Port 1	220 _H	
PHY_C2	PHY Control Register of Port 2	240 _H	
PHY_C3	PHY Control Register of Port 3	260 _H	
PHY_C4	PHY Control Register of Port 4	280 _H	

PHY Status Register of Port 0

PHY_S0 **Offset**
PHY Status Register of Port 0 **201_H** **Reset Value**
7849_H

	15	14	13	12	11	10	9	8	7	6	5	4	3	2	1	0
	CAP_T4	CAP_TXF	CAP_TXH	CAP_TF	CAP_TH	CAP_T2	Res			CAP_SUPR	AN_COMP	REM_FLT	CAP_ANEG	LINK	JAB	EXTR EG
	ro	ro	ro	ro	ro	ro				ro	ro	ro	ro	ro	ro	ro

Field	Bits	Type	Description
CAP_T4	15	ro	100Base-T4 Capable Set to 0 all the time to indicate that the PHY does not support 100Base-T4
CAP_TXF	14	ro	100Base-X Full Duplex Capable Set to 1 all the time to indicate that the PHY does support Full Duplex mode
CAP_TXH	13	ro	100Base-X Half Duplex Capable Set to 1 all the time to indicate that the PHY does support Half Duplex mode
CAP_TF	12	ro	10M Full Duplex Capable TP : Set to 1 all the time to indicate that the PHY does support 10M Full Duplex mode FX : Set to 0 all the time to indicate that the PHY does not support 10M Full Duplex mode
CAP_TH	11	ro	10M Half Duplex Capable TP : Set to 1 all the time to indicate that the PHY does support 10M Half Duplex mode FX : Set to 0 all the time to indicate that the PHY does not support 10M Half Duplex mode

16 Bits Mode Registers Description

Field	Bits	Type	Description
CAP_T2	10	ro	100Base-T2 Capable Set to 0 all the time to indicate that the PHY does not support 100Base-T2
CAP_SUPR	6	ro	MF Preamble Suppression Capable This bit is hardwired to 1 indicating that the PHY accepts management frame without preamble. Minimum 32 preamble bits are required following power-on or hardware reset. One idle bit is required between any two management transactions as per IEEE 802.3u specification.
AN_COMP	5	ro	Auto Negotiation Complete If auto negotiation is enabled, this bit indicates whether the auto negotiation process has been completed or not. Set to 0 all the time when Fiber Mode is selected. 0 _B Auto Negotiation process not completed 1 _B Auto Negotiation process completed
REM_FLT	4	ro	Remote Fault Detect This bit is latched to 1 if the RF bit in the auto negotiation link partner ability register (bit 13, register address 05 _H) is set or the receive channel meets the far end fault indication function criteria. It is unlatched when this register is read. 0 _B Remote Fault not detected 1 _B Remote Fault detected
CAP_ANEG	3	ro	Auto Negotiation Ability TP : This bit is set to 1 all the time, indicating that PHY is capable of auto negotiation. FX : This bit is set to 0 all the time, indicating that PHY is not capable of auto negotiation in Fiber Mode. 0 _B Not capable of auto negotiation 1 _B Capable of auto negotiation
LINK	2	ro	Link Status This bit reflects the current state of the link – test-fail state machine. Loss of a valid link causes a 0 latched into this bit. It remains 0 until this register is read by the serial management interface. Whenever Linkup, this bit should be read twice to get link up status 0 _B Link is down 1 _B Link is up
JAB	1	ro	Jabber Detect 0 _B Jabber condition not detected 1 _B Jabber condition detected
EXTREG	0	ro	Extended Capability This bit defaults to 1, indicating that the PHY implements extended registers. 0 _B No extended register set 1 _B Extended register set

Similar Registers

All PHY_Sx registers have the same structure and characteristics, see [PHY_S0](#).
The offset addresses of the other PHY_Sx registers are listed in [Table 49](#).

Table 49 PHY_Sx Registers

Register Short Name	Register Long Name	Offset Address	Page Number
PHY_S1	PHY Status Register of Port 1	221 _H	
PHY_S2	PHY Status Register of Port 2	241 _H	
PHY_S3	PHY Status Register of Port 3	261 _H	
PHY_S4	PHY Status Register of Port 4	281 _H	

PHY Identifier Register of Port 0 (A)

PHY_I0_A	Offset	Reset Value
PHY Identifier Register of Port 0 (A)	202 _H	0302 _H

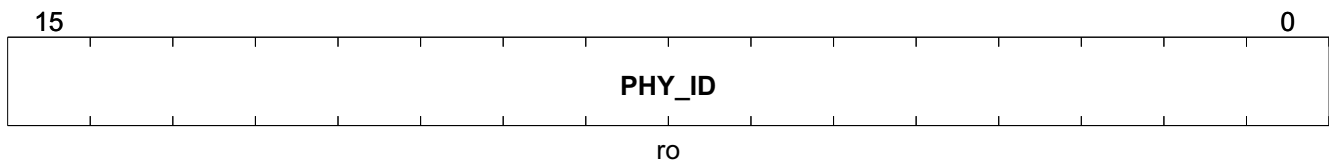

Field	Bits	Type	Description
PHY_ID	15:0	ro	IEEE Address

Similar Registers

All PHY_Ix_A registers have the same structure and characteristics, see [PHY_I0_A](#). The offset addresses of the other PHY_Ix_A registers are listed in [Table 50](#).

Table 50 PHY_Ix_A Registers

Register Short Name	Register Long Name	Offset Address	Page Number
PHY_I1_A	PHY Identifier Register of Port 1 (A)	222 _H	
PHY_I2_A	PHY Identifier Register of Port 2 (A)	242 _H	
PHY_I3_A	PHY Identifier Register of Port 3 (A)	262 _H	
PHY_I4_A	PHY Identifier Register of Port 4 (A)	282 _H	

PHY Identifier Register of Port 0 (B)

PHY_I0_B	Offset	Reset Value
PHY Identifier Register of Port 0 (B)	203 _H	6071 _H

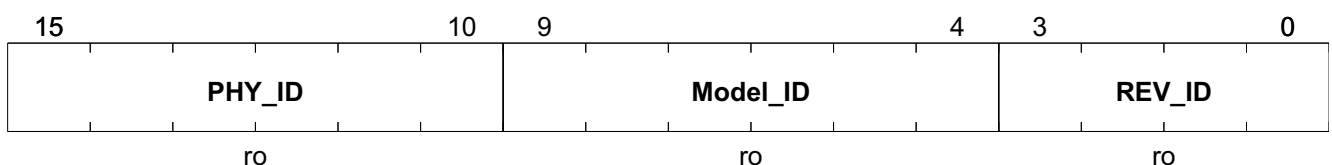

Field	Bits	Type	Description
PHY_ID	15:10	ro	IEEE Address
Model_ID	9:4	ro	IEEE Model No.
REV_ID	3:0	ro	IEEE Revision No.

Similar Registers

All PHY_Ix_B registers have the same structure and characteristics, see [PHY_I0_B](#).
The offset addresses of the other PHY_Ix_B registers are listed in [Table 51](#).

Table 51 PHY_Ix_B Registers

Register Short Name	Register Long Name	Offset Address	Page Number
PHY_I1_B	PHY Identifier Register of Port 1 (B)	223 _H	
PHY_I2_B	PHY Identifier Register of Port 2 (B)	243 _H	
PHY_I3_B	PHY Identifier Register of Port 3 (B)	263 _H	
PHY_I4_B	PHY Identifier Register of Port 4 (B)	283 _H	

Auto Negotiation Advertisement Register of Port 0

ANAP0 **Offset**
Auto Negotiation Advertisement Register of **204_H**
Port 0 **Reset Value**
05E1_H

15	14	13	12	11	10	9	8	7	6	5	4	0	
NP	Res	RF	Res	ASM DIR	PAUSE	T4	TX F DX	TX H DX	10 F DX	10 H DX	SF		
ro		ro		rw	rw	ro	rw	rw	rw	rw	ro		

Field	Bits	Type	Description
NP	15	ro	Next Page This bit is defaults to 1, indicating that PHY is next page capable
RF	13	ro	Remote Fault This bit is written by serial management interface for the purpose of communicating the remote fault condition to the auto negotiation link partner. 0 _B No remote fault has been detected 1 _B Remote Fault has been detected
ASM_DIR	11	rw	Asymmetric Pause Direction Bit[11:10] Capability 00 _B No Pause 01 _B Symmetric PAUSE 10 _B Asymmetric PAUSE toward Link Partner 11 _B Both Symmetric PAUSE and Asymmetric PAUSE toward local device

16 Bits Mode Registers Description

Field	Bits	Type	Description
PAUSE	10	rw	Pause Operation for Full Duplex Value on PAUREC will be stored in this bit during power on reset.
T4	9	ro	Technology Ability for 100Base-T4 Defaults to 0.
TX_FDX	8	rw	100Base-TX Full Duplex 0 _B Not capable of 100M Full duplex operation 1 _B Capable of 100M Full duplex operation
TX_HDX	7	rw	100Base-TX Half Duplex 0 _B Not capable of 100M operation 1 _B Capable of 100M operation
10_FDX	6	rw	10BASE-T Full Duplex 0 _B Not capable of 10M full duplex operation 1 _B Capable of 10M Full Duplex operation
10_HDX	5	rw	10Base-T Half Duplex <i>Note: Bit 8:5 should be combined with REC100, RECFUL pin input to determine the finalized speed and duplex mode.</i> 0 _B Not capable of 10M operation 1 _B Capable of 10M operation
SF	4:0	ro	Selector Field These 5 bits are hardwired to 00001 _B , indicating that the PHY supports IEEE 802.3 CSMA/CD.

Similar Registers

All ANAPx registers have the same structure and characteristics, see [ANAP0](#).
The offset addresses of the other ANAPx registers are listed in [Table 52](#).

Table 52 ANAPx Registers

Register Short Name	Register Long Name	Offset Address	Page Number
ANAP1	Auto Negotiation Advertisement Register of Port 1	224 _H	
ANAP2	Auto Negotiation Advertisement Register of Port 2	244 _H	
ANAP3	Auto Negotiation Advertisement Register of Port 3	264 _H	
ANAP4	Auto Negotiation Advertisement Register of Port 4	284 _H	

Auto Negotiation Link Partner Ability Register of Port 0

ANLPA0	Offset	Reset Value
Auto Negotiation Link Partner Ability Register of Port 0	205_H	01E1_H

15	14	13	12	11	10	9	8	7	6	5	4			0
NPAG E	ACK	RF	Res	LP_D IR	LP_P AU	LP_T 4	LP_F DX	LP_H DX	LP_F 10	LP_H 10			SF	
ro	ro	ro		ro	ro	ro	ro	ro	ro	ro			ro	

16 Bits Mode Registers Description

Field	Bits	Type	Description
NPAGE	15	ro	Next Page 0 _B Not capable of next page function 1 _B Capable of next page function
ACK	14	ro	Acknowledge 0 _B Not acknowledged 1 _B Link Partner acknowledges reception of the ability data word
RF	13	ro	Remote Fault 0 _B No remote fault has been detected 1 _B Remote Fault has been detected
LP_DIR	11	ro	Link Partner Asymmetric Pause Direction
LP_PAU	10	ro	Link Partner Pause CapabilityValue on PAUREC Will be stored in this bit during power on reset.
LP_T4	9	ro	Link Partner Technology Ability For 100Base-T4Defaults to 0.
LP_FDX	8	ro	100Base-TX Full Duplex 0 _B Not capable of 100M Full duplex operation 1 _B Capable of 100M Full duplex operation
LP_HDX	7	ro	100Base-TX Half Duplex 0 _B Not capable of 100M operation 1 _B Capable of 100M operation
LP_F10	6	ro	10BASE-T Full Duplex 0 _B Not capable of 10M full duplex operation 1 _B Capable of 10M Full Duplex operation
LP_H10	5	ro	10Base-T Half Duplex 0 _B Not capable of 10M operation 1 _B Capable of 10M operation
SF	4:0	ro	Selector Field Encoding Definitions

Similar Registers

All ANLPAx registers have the same structure and characteristics, see [ANLPA0](#).

The offset addresses of the other ANLPAx registers are listed in [Table 53](#).

Table 53 ANLPAx Registers

Register Short Name	Register Long Name	Offset Address	Page Number
ANLPA1	Auto Negotiation Link Partner Ability Register of Port 1	225 _H	
ANLPA2	Auto Negotiation Link Partner Ability Register of Port 2	245 _H	
ANLPA3	Auto Negotiation Link Partner Ability Register of Port 3	265 _H	
ANLPA4	Auto Negotiation Link Partner Ability Register of Port 4	285 _H	

16 Bits Mode Registers Description

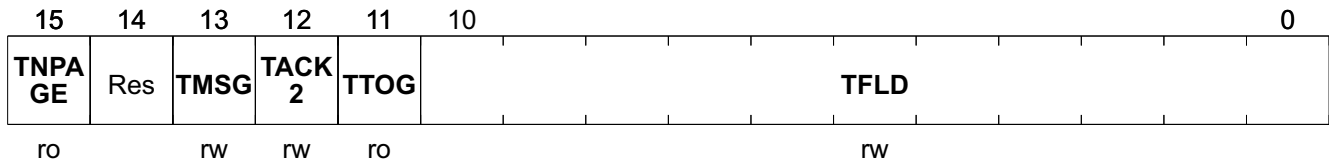

Field	Bits	Type	Description
TNPAGE	15	ro	Transmit Next Page Transmit Code Word Bit 15
TMSG	13	rw	Transmit Message Page Transmit Code Word Bit 13
TACK2	12	rw	Transmit Acknowledge 2 Transmit Code Word Bit 12
TTOG	11	ro	Transmit Toggle Transmit Code Word Bit 11
TFLD	10:0	rw	Transmit Message Field Transmit Code Word Bit 10..0

Similar Registers

All NPTx registers have the same structure and characteristics, see [NPT0](#).
The offset addresses of the other NPTx registers are listed in [Table 55](#).

Table 55 NPTx Registers

Register Short Name	Register Long Name	Offset Address	Page Number
NPT1	Next Page Transmit Register of Port 1	227 _H	
NPT2	Next Page Transmit Register of Port 2	247 _H	
NPT3	Next Page Transmit Register of Port 3	267 _H	
NPT4	Next Page Transmit Register of Port 4	287 _H	

Link Partner Next Page Register of Port 0

LPNP0	Offset	Reset Value
Link Partner Next Page Register of Port 0	208 _H	0000 _H

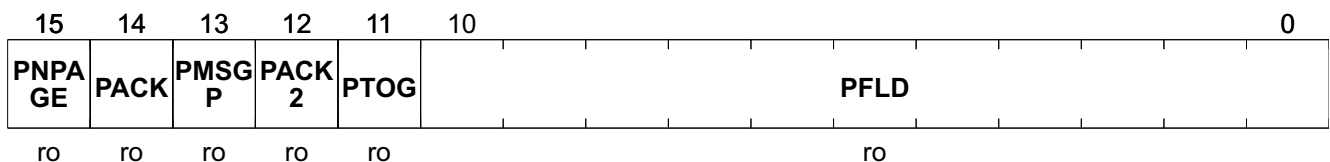

Field	Bits	Type	Description
PNPAGE	15	ro	Link Partner Next Page Receive Code Word Bit 15

16 Bits Mode Registers Description

Field	Bits	Type	Description
PACK	14	ro	Link Partner Acknowledge Receive Code Word Bit 14
PMSGP	13	ro	Link Partner Message Page Receive Code Word Bit 13
PACK2	12	ro	Link Partner Acknowledge 2 Receive Code Word Bit 12
PTOG	11	ro	Link Partner Toggle Receive Code Word Bit 11
PFLD	10:0	ro	Link Partner Message Field Receive Code Word Bit 11

Similar Registers

All LPNPx registers have the same structure and characteristics, see [LPNP0](#).
The offset addresses of the other LPNPx registers are listed in [Table 56](#).

Table 56 LPNPx Registers

Register Short Name	Register Long Name	Offset Address	Page Number
LPNP1	Link Partner Next Page Register of Port 1	228 _H	
LPNP2	Link Partner Next Page Register of Port 2	248 _H	
LPNP3	Link Partner Next Page Register of Port 3	268 _H	
LPNP4	Link Partner Next Page Register of Port 4	288 _H	

6 Electrical Specification

6.1 TX/FX Interface

6.1.1 TP Interface

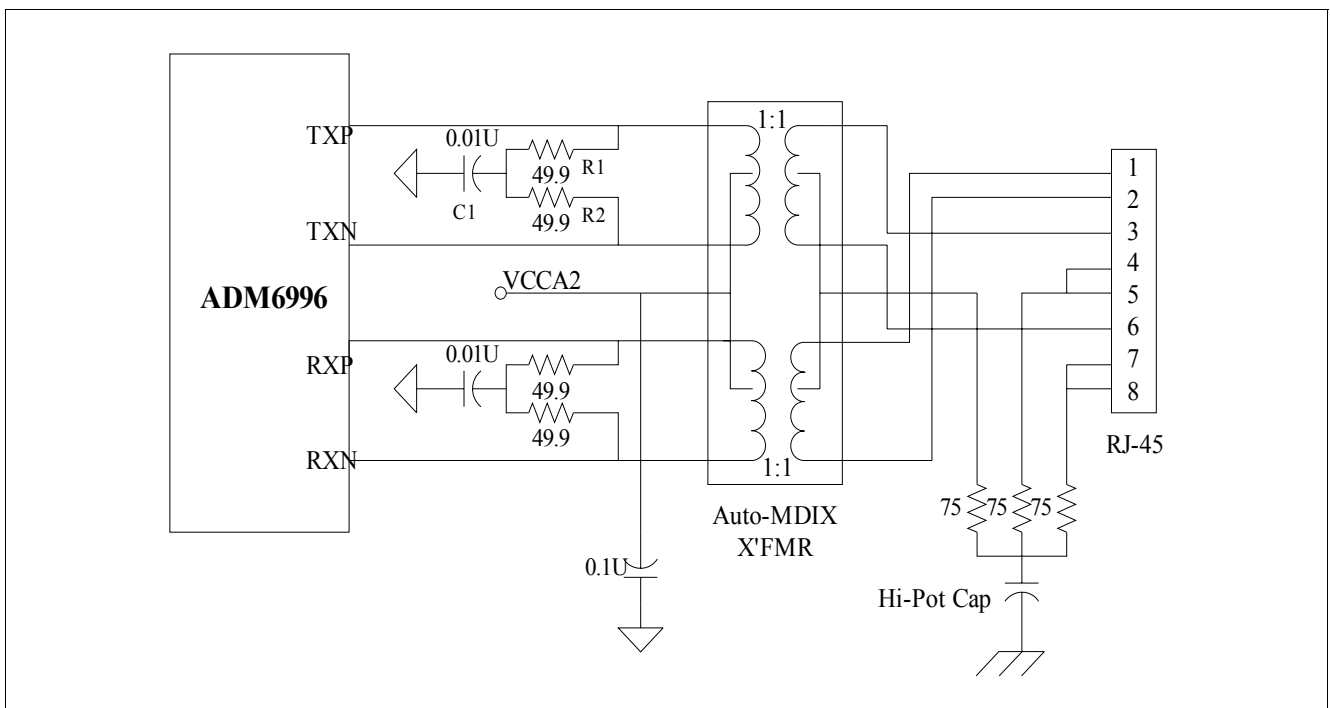

Figure 16 TP Interface

Transformer requirements:

- TX/RX rate 1:1
- TX/RX central tap connect together to VCCA2

Users can change the TX/RX pin for easy layout but do not change the polarity. ADM6996FC/FCX/FHX supports auto polarity on the receiving side.

6.1.2 FX Interface

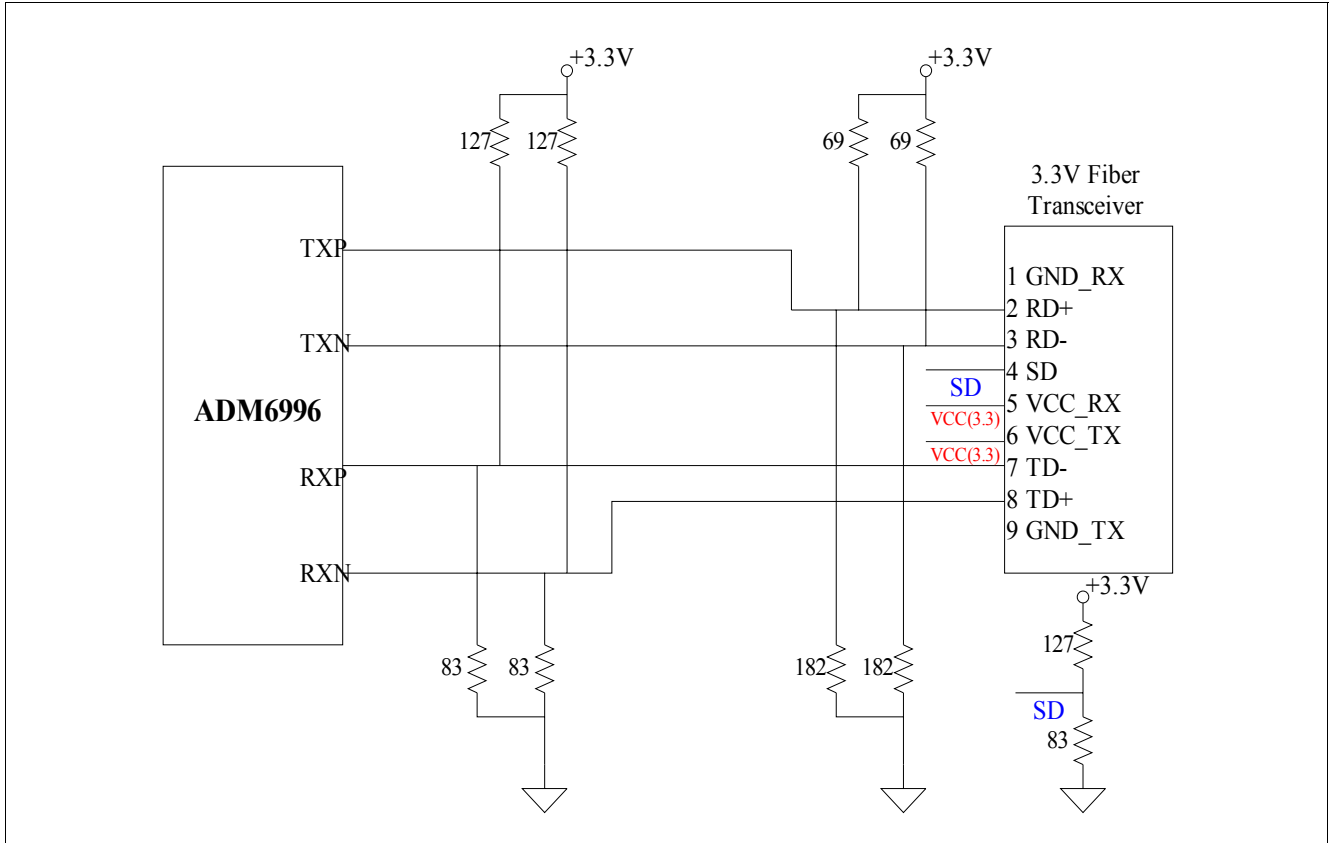

Figure 17 FX Interface

6.2 DC Characterization

Table 57 Power Consumption

Parameter	Symbol	Values			Unit	Note / Test Condition
		Min.	Typ.	Max.		
Power consumption when all twisted pair ports are linked at 100 Mbit/s.	P_{100M_5TP}	—	980	—	mW	Under EEPROM Register 29 _H = C000 _H , and 30 _H = 985 _H
Power consumption when all twisted pair ports are linked at 10 Mbit/s (include transformer).	P_{10M_5TP}	—	1450	—	mW	Under EEPROM Register 29 _H = C000 _H , and 30 _H = 985 _H
Power consumption when all twisted pair ports are disconnected.	P_{DIS_5TP}	—	500	—	mW	Under EEPROM Register 29 _H = C000 _H , and 30 _H = 985 _H

Table 58 Absolute Maximum Ratings

Parameter	Symbol	Values			Unit	Note / Test Condition
		Min.	Typ.	Max.		
3.3 V Power Supply for I/O pad	V_{CC30}	2.97	3.3	3.63	V	–
3.3 V Power Supply for bias circuit	V_{CCBS}	2.97	3.3	3.63	V	–
3.3 V Power Supply for A/D converter	V_{CCAD}	2.97	3.3	3.63	V	–
1.8 V Power Supply for line driver	V_{CCA2}	1.62	1.8	1.98	V	–
1.8 V Power Supply for PLL	V_{CCPLL}	1.62	1.8	1.98	V	–
1.8 V Power Supply for Digital core	V_{CCIK}	1.62	1.8	1.98	V	–
Input Voltage	V_{IN}	-0.3	–	$V_{CC30} + 0.3$	V	–
Output Voltage	V_{out}	-0.3	–	$V_{CC30} + 0.3$	V	–
Maximum current for 3.3 V power supply	$I_{3.3VMAX}$	–	–	100	mA	–
Maximum current for 1.8 V power supply (include transformer)	$I_{1.8VMAX}$	–	–	800	mA	–
Storage Temperature	T_{STG}	-55	–	155	°C	–
Thermal Resistance	θ_{JA}		33.0		°C/W	ADM6996FC/FCX
	θ_{JC}		14.9		°C/W	ADM6996FC/FCX
	θ_{JA}		24.7		°C/W	ADM6996FHX
	θ_{JC}		11.4		°C/W	ADM6996FHX
ESD Rating	ESD	1.0	–	–	kV	–

Attention: Stresses above the max. values listed here may cause permanent damage to the device. Exposure to absolute maximum rating conditions for extended periods may affect device reliability. Maximum ratings are absolute ratings; exceeding only one of these values may cause irreversible damage to the integrated circuit.

Table 59 Recommended Operating Conditions

Parameter	Symbol	Values			Unit	Note / Test Condition
		Min.	Typ.	Max.		
3.3 V Power Supply for I/O pad	V_{CC30}	3.135	3.3	3.465	V	–
3.3 V Power Supply for bias circuit	V_{CCBS}	3.135	3.3	3.465	V	–
3.3 V Power Supply for A/D converter	V_{CCAD}	3.135	3.3	3.465	V	–
1.8 V Power Supply for line driver	V_{CCA2}	1.71	1.8	1.89	V	–
1.8 V Power Supply for PLL	V_{CCPLL}	1.71	1.8	1.89	V	–

Table 59 Recommended Operating Conditions (cont'd)

Parameter	Symbol	Values			Unit	Note / Test Condition
		Min.	Typ.	Max.		
1.8 V Power Supply for Digital core	V_{CCIK}	1.71	1.8	1.89	V	–
Input Voltage	V_{in}	0	–	V_{CC}	V	–
Junction Operating Temperature	T_j	0	25	115	°C	–

Table 60 DC Electrical Characteristics for 3.3 V Operation¹⁾

Parameter	Symbol	Values			Unit	Note / Test Condition
		Min.	Typ.	Max.		
Input Low Voltage	V_{IL}	–	–	0.8	V	TTL
Input High Voltage	V_{IH}	2.0	–	–	V	TTL
Output Low Voltage	V_{OL}	–	–	0.4	V	TTL
Output High Voltage	V_{OH}	2.4	–	–	V	TTL
Input Pull-up/down Resistance	R_I	–	50	–	kΩ	$V_{IL} = 0\text{ V}$ or $V_{IH} = V_{CC30}$

1) Under $V_{CC30} = 2.97\text{ V} \sim 3.63\text{ V}$, $T_j = 0\text{ °C} \sim 115\text{ °C}$

6.3 AC Characterization

6.3.1 XTAL/OSC Timing

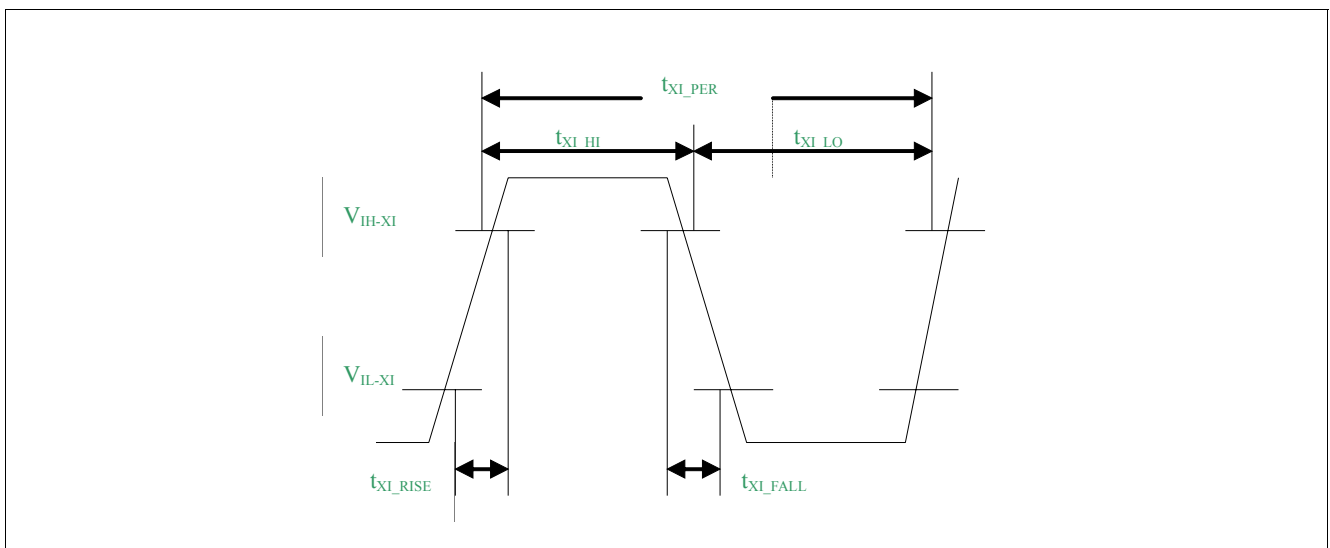

Figure 18 XTAL/OSC Timing

Table 61 XTAL/OSC Timing

Parameter	Symbol	Values			Unit	Note / Test Condition
		Min.	Typ.	Max.		
XI/OSCI Clock Period	t_{XI_PER}	40.0 - 50ppm	40.0	40.0 + 50ppm	ns	–
XI/OSCI Clock High	t_{XI_HI}	14	20.0	–	ns	–
XI/OSCI Clock Low	t_{XI_LO}	14	20.0	–	ns	–
XI/OSCI Clock Rise Time, V_{IL} (max) to V_{IH} (min.)	t_{XI_RISE}	–	–	4	ns	–
XI/OSCI Clock Fall Time, V_{IH} (min.) to V_{IL} (max)	t_{XI_FALL}	–	–	4	ns	–

6.3.2 Power On Reset

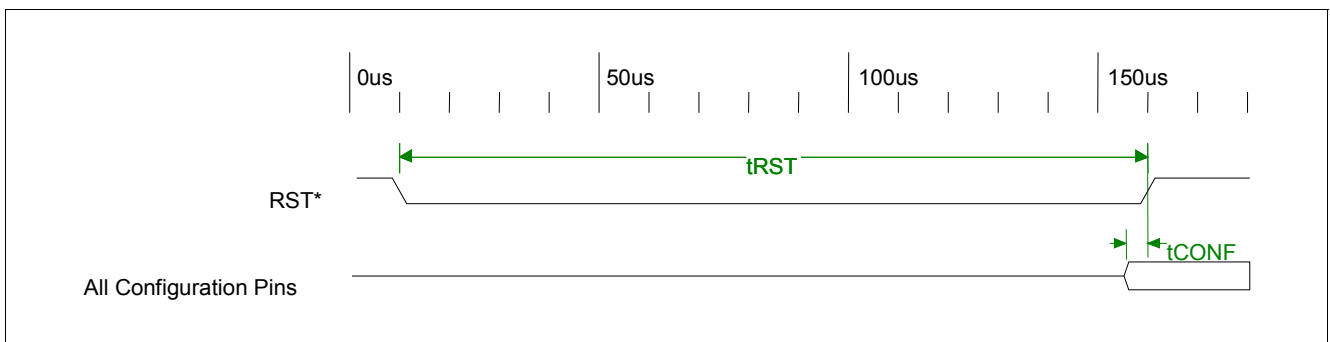

Figure 19 Power On Reset Timing

Table 62 Power On Reset Timing

Parameter	Symbol	Values			Unit	Note / Test Condition
		Min.	Typ.	Max.		
RST Low Period	t_{RST}	100	–	–	ms	–
Start of Idle Pulse Width	t_{CONF}	100	–	–	ns	–

6.3.3 EEPROM Interface Timing

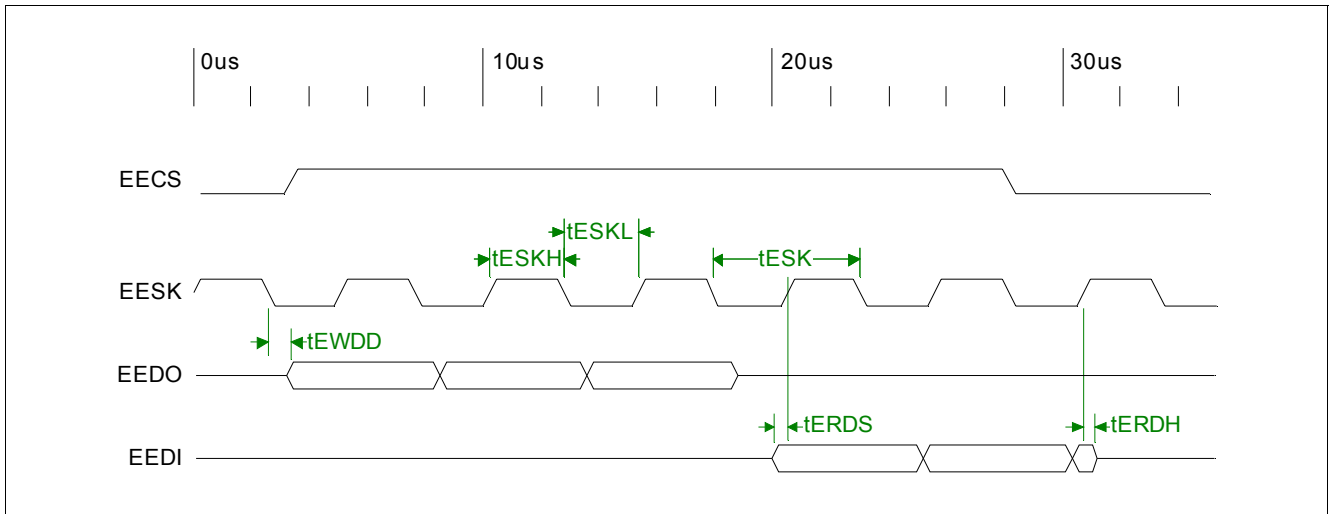

Figure 20 EEPROM Interface Timing

Table 63 EEPROM Interface Timing

Parameter	Symbol	Values			Unit	Note / Test Condition
		Min.	Typ.	Max.		
EESK Period	t_{ESK}	–	5120	–	ns	–
EESK Low Period	t_{ESKL}	2550	–	2570	ns	–
EESK High Period	t_{ESKH}	2550	–	2570	ns	–
EEDI to EESK Rising Setup Time	t_{ERDS}	10	–	–	ns	–
EEDI to EESK Rising Hold Time	t_{ERDH}	10	–	–	ns	–
EESK Falling to EEDO Output Delay Time	t_{EWDD}	–	–	20	ns	–

6.3.4 10Base-TX MII Input Timing

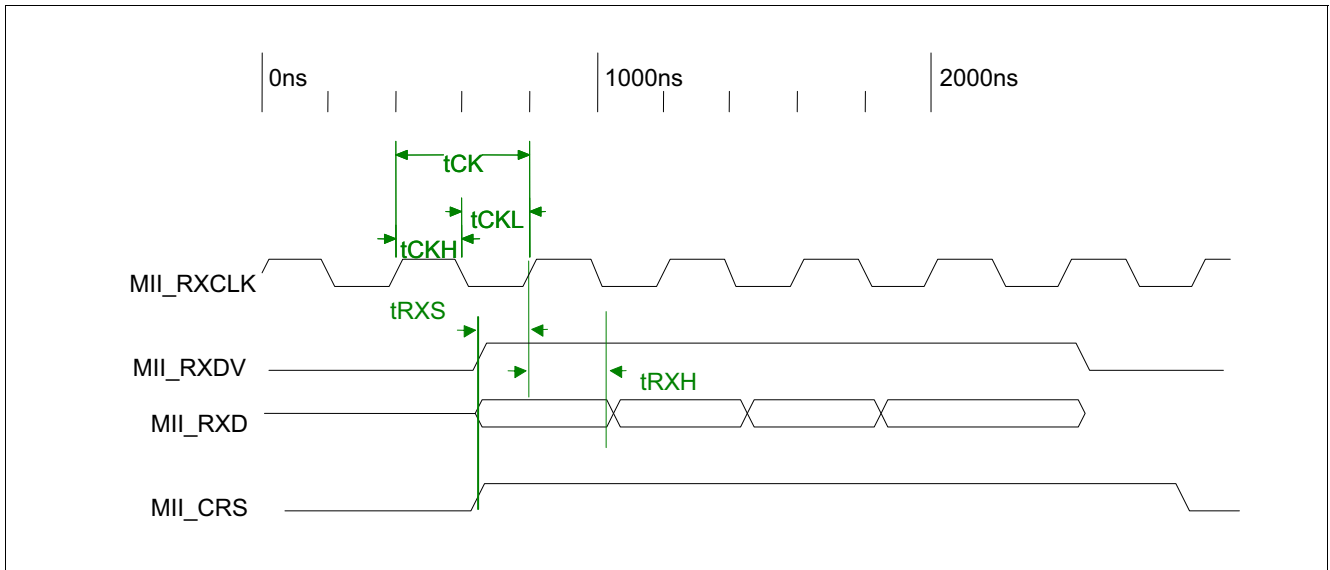

Figure 21 10Base-TX MII Input Timing

Table 64 10Base-TX MII Input Timing

Parameter	Symbol	Values			Unit	Note / Test Condition
		Min.	Typ.	Max.		
MII_RXCLK Period	t_{CK}	–	400	–	ns	–
MII_RXCLK Low Period	t_{CKL}	180	–	220	ns	–
MII_RXCLK High Period	t_{CKH}	180	–	220	ns	–
MII_CRS, MII_RXDV and MII_RXD to MII_RXCLK rising setup	t_{RXS}	10	–	–	ns	–
MII_CRS, MII_RXDV and MII_RXD to MII_RXCLK rising hold	t_{RXH}	10	–	–	ns	–

6.3.5 10Base-TX MII Output Timing

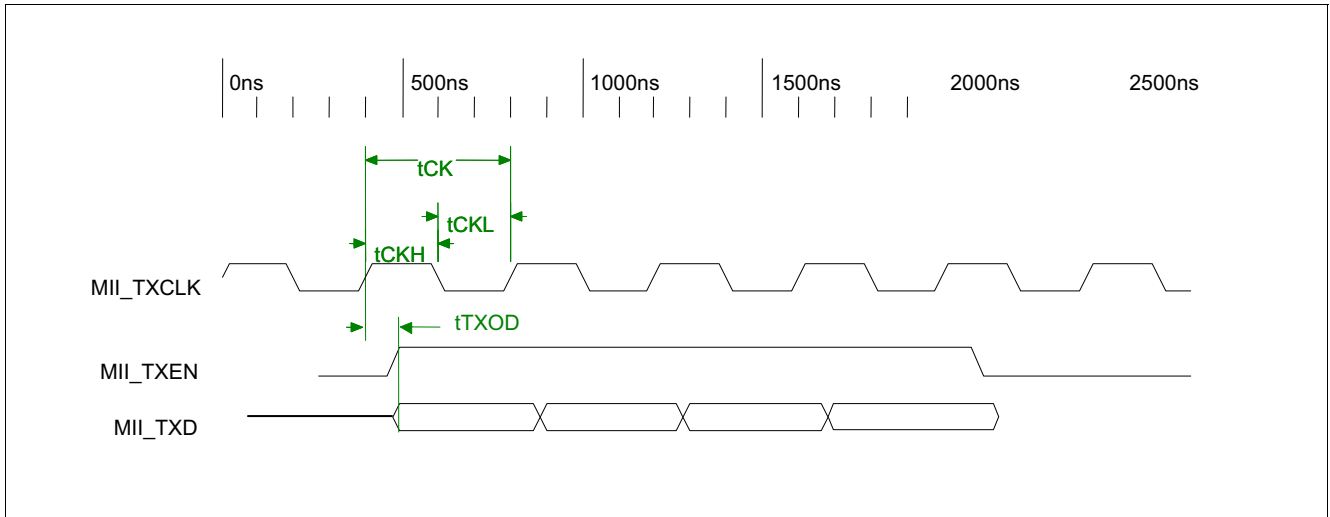

Figure 22 10Base-TX MII Output Timing

Table 65 10-Base-TX MII Output Timing

Parameter	Symbol	Values			Unit	Note / Test Condition
		Min.	Typ.	Max.		
MII_TXCLK Period	t_{CK}	–	400	–	ns	–
MII_TXCLK Low Period	t_{CKL}	180	–	220	ns	–
MII_TXCLK High Period	t_{CKH}	180	–	220	ns	–
MII_TXD, MII_TXEN to MII_TXCLK Rising Output Delay	t_{TXOD}	0	–	25	ns	–

6.3.6 100Base-TX MII Input Timing

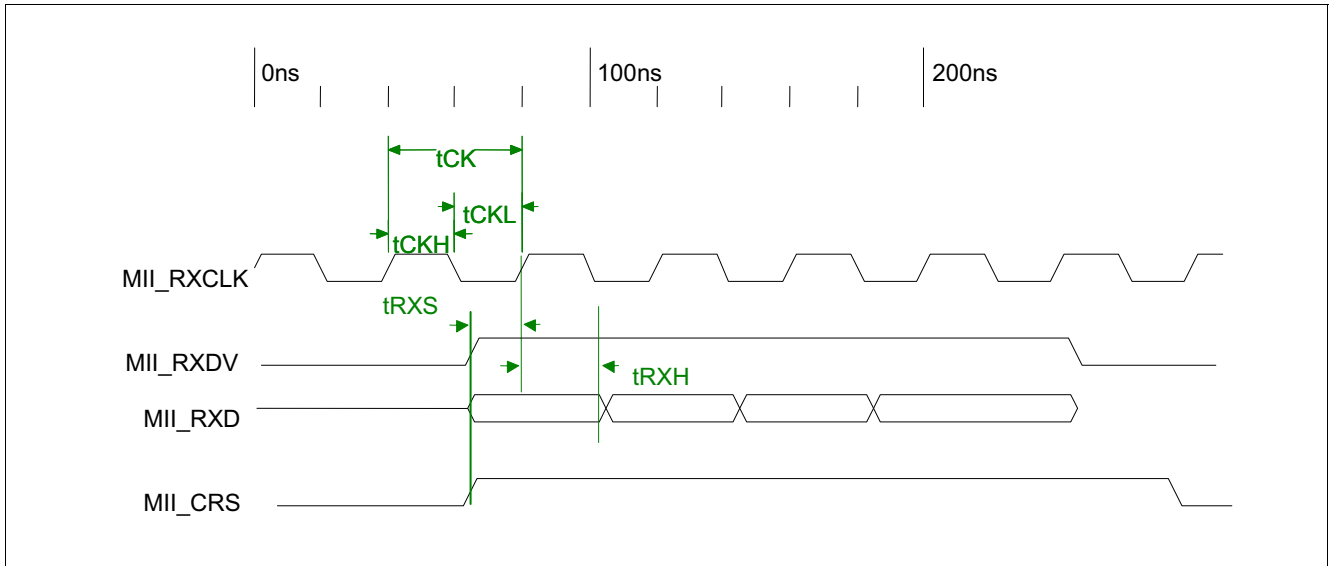

Figure 23 100Base-TX MII Input Timing

Table 66 100Base-TX MII Input Timing

Parameter	Symbol	Values			Unit	Note / Test Condition
		Min.	Typ.	Max.		
MII_RXCLK Period	t_{CK}	–	40	–	ns	–
MII_RXCLK Low Period	t_{CKL}	18	–	22	ns	–
MII_RXCLK High Period	t_{CKH}	18	–	22	ns	–
MII_CRS, MII_RXDV and MII_RXD to MII_RXCLK rising setup	t_{RXS}	10	–	–	ns	–
MII_CRS, MII_RXDV and MII_RXD to MII_RXCLK rising hold	t_{RXH}	10	–	–	ns	–

6.3.7 100Base-TX MII Output Timing

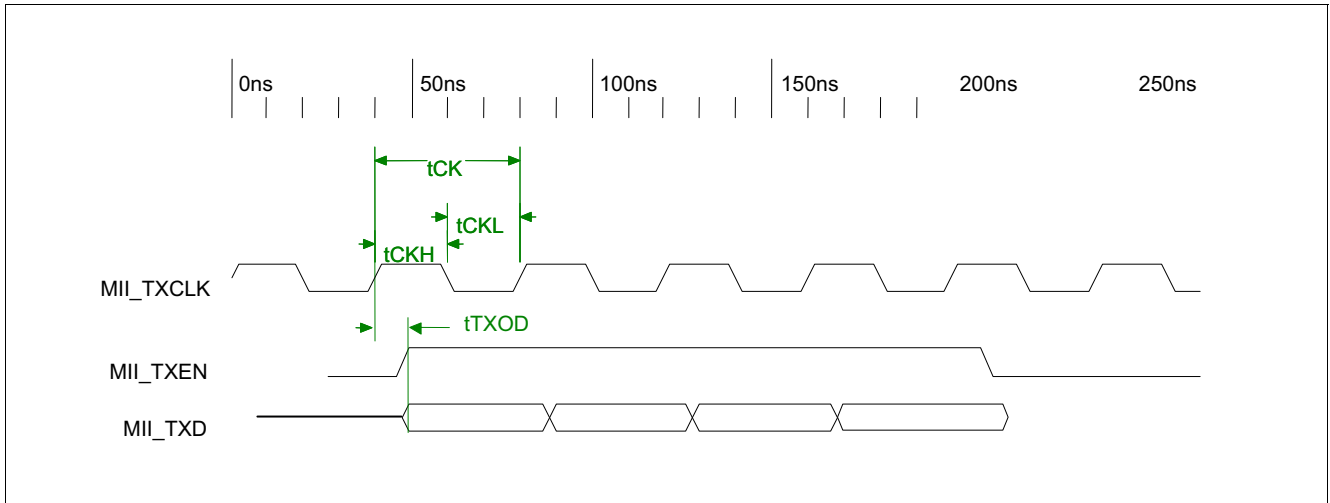

Figure 24 100Base-TX MII Output Timing

Table 67 100Base-TX MII Output Timing

Parameter	Symbol	Values			Unit	Note / Test Condition
		Min.	Typ.	Max.		
MII_TXCLK Period	t_{CK}	–	40	–	ns	–
MII_TXCLK Low Period	t_{CKL}	18	–	22	ns	–
MII_TXCLK High Period	t_{CKH}	18	–	22	ns	–
MII_TXD, MII_TXEN to MII_TXCLK Rising Output Delay	t_{TXOD}	0	–	25	ns	–

6.3.8 RMII REFCLK Input Timing

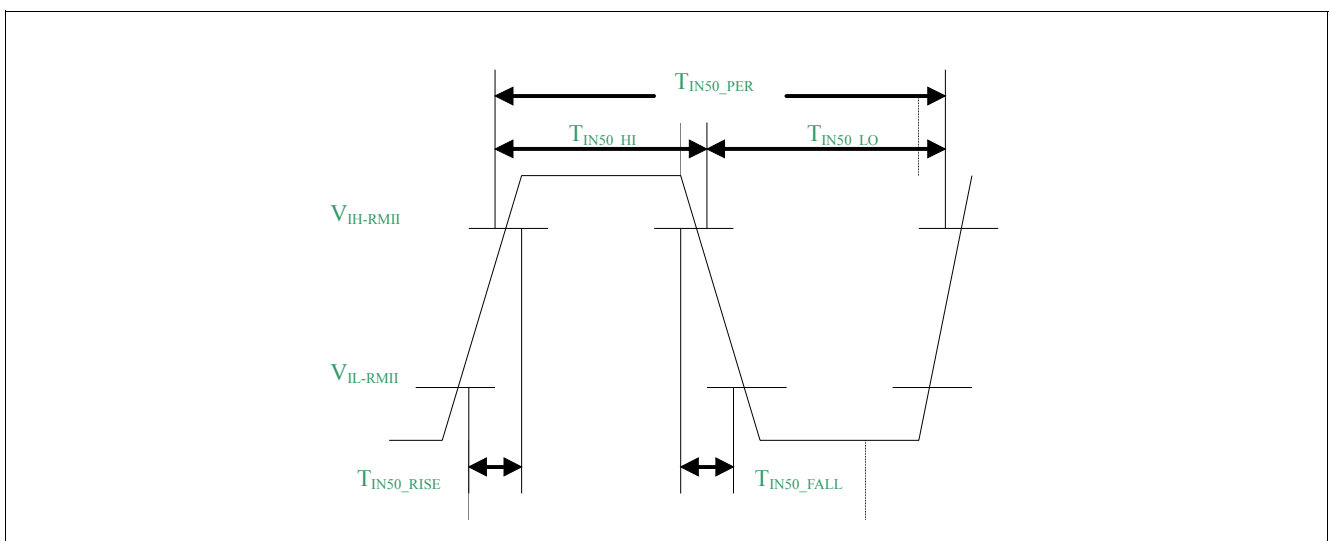

Figure 25 RMII REFCLK Input Timing

Table 68 RMI REFCLK Input Timing

Parameter	Symbol	Values			Unit	Note / Test Condition
		Min.	Typ.	Max.		
REFCLK Clock Period	t_{IN50_PER}	40.0 - 50ppm	40.0	40.0 + 50ppm	ns	–
REFCLK Clock High	t_{IN50_HI}	14	20.0	–	ns	–
REFCLK Clock Low	t_{IN50_LO}	14	20.0	–	ns	–
REFCLK Clock Rise Time, V_{IL} (max) to V_{IH} (min.)	t_{IN50_RISE}	–	–	2	ns	–
REFCLK Clock Fall Time, V_{IH} (min.) to V_{IL} (max)	t_{IN50_FALL}	–	–	2	ns	–

6.3.9 RMI REFCLK Output Timing

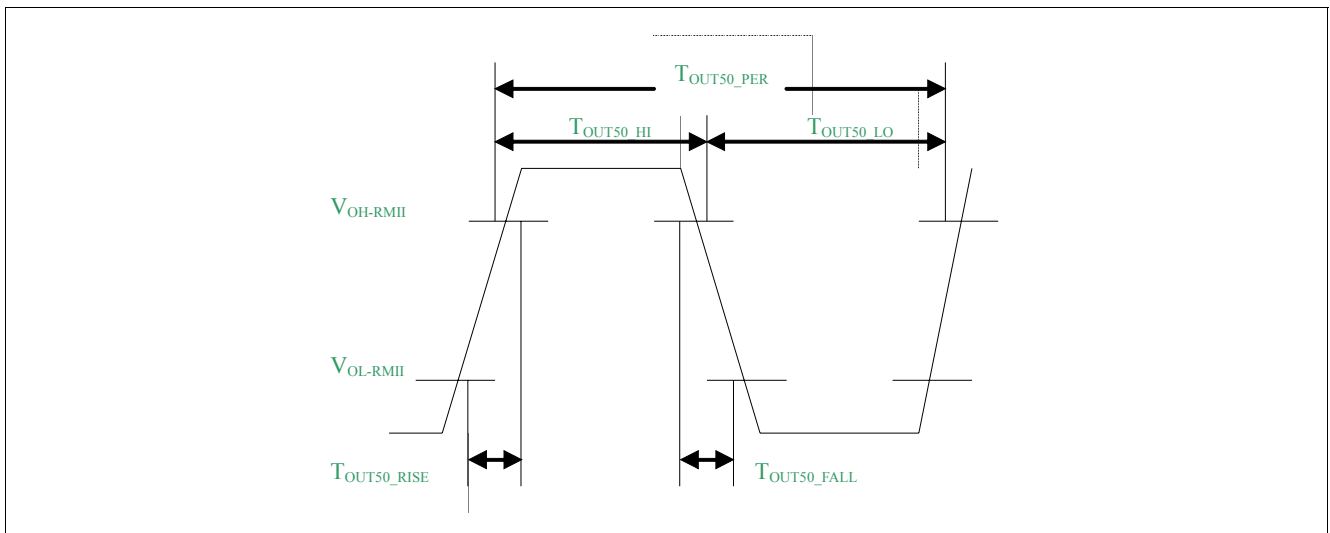

Figure 26 RMI REFCLK Output Timing

Table 69 RMI REFCLK Output Timing

Parameter	Symbol	Values			Unit	Note / Test Condition
		Min.	Typ.	Max.		
REFCLK Clock Period	t_{OUT50_PER}	40.0 - 50ppm	40.0	40.0 + 50ppm	ns	–
REFCLK Clock High	t_{OUT50_HI}	14	20.0	26	ns	–
REFCLK Clock Low	t_{OUT50_LO}	14	20.0	26	ns	–
REFCLK Clock Rise Time, V_{OL} (max) to V_{OH} (min.)	t_{OUT50_RISE}	–	–	2	ns	–
REFCLK Clock Fall Time, V_{OH} (min.) to V_{OL} (max)	t_{OUT50_FALL}	–	–	2	ns	–
REFCLK Clock Jittering (p-p)	t_{OUT50_JIT}	–	0.15	–	ns	–

6.3.10 Reduce MII Timing

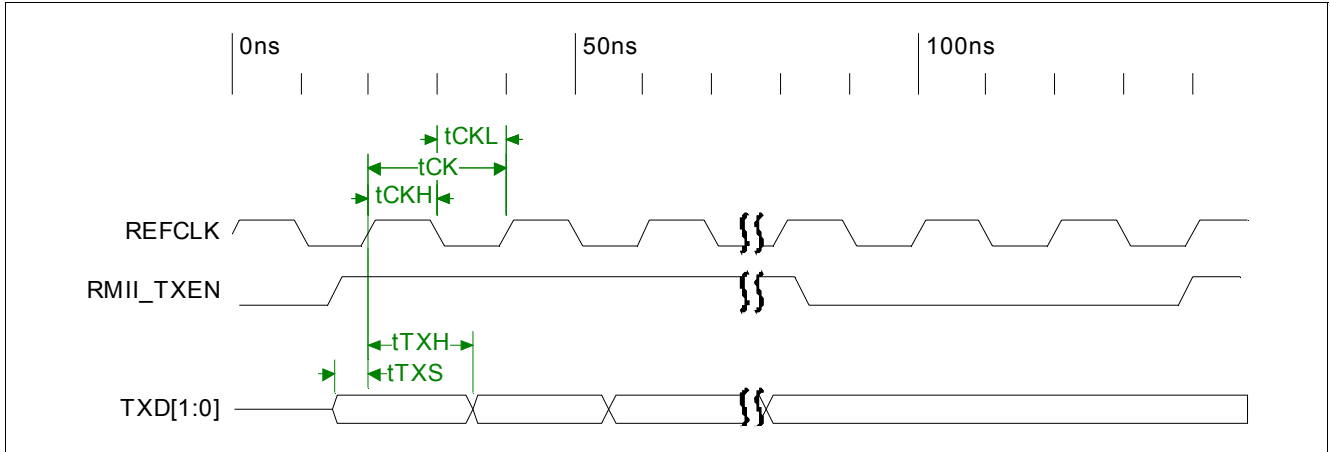

Figure 27 Reduce MII Timing (1 of 2)

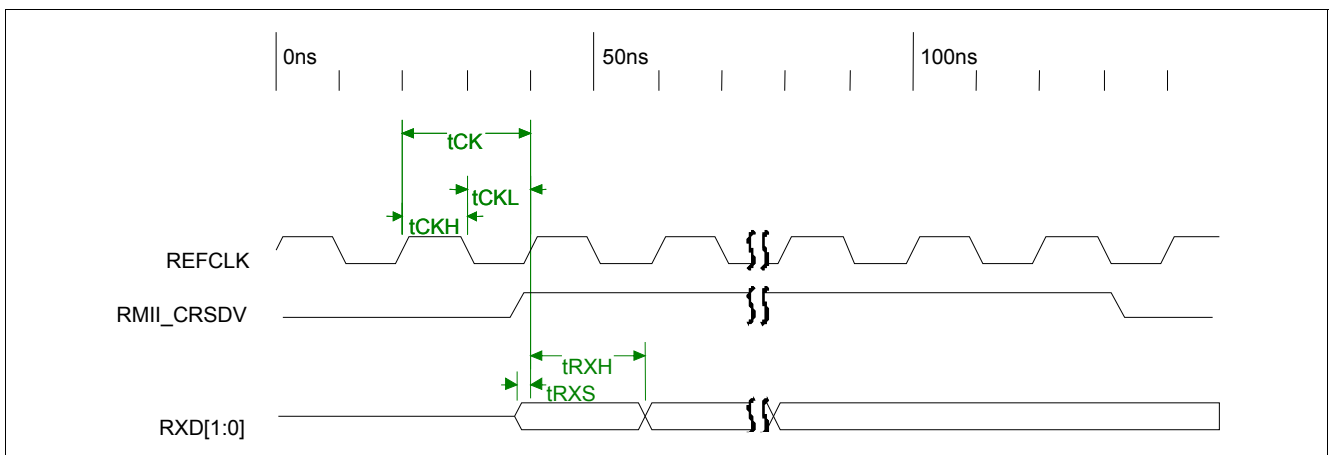

Figure 28 Reduce MII Timing (2 of 2)

Table 70 Reduce MII Timing

Parameter	Symbol	Values			Unit	Note / Test Condition
		Min.	Typ.	Max.		
RMII_REFCLK Period	t_{CK}	–	20	–	ns	–
RMII_REFCLK Low Period	t_{CKL}	–	10	–	ns	–
RMII_REFCLK High Period	t_{CKH}	–	10	–	ns	–
TXEN, TXD to REFCLK rising setup time	t_{TXS}	4	–	–	ns	–
TXE, TXD to REFCLK rising hold time	t_{TXH}	2	–	–	ns	–
CRSDV, RXD to REFCLK rising setup time	t_{RXS}	4	–	–	–	–
CRSDV, RXD to REFCLK rising hold time	t_{RXH}	2	–	–	–	–

6.3.11 GPSI (7-wire) Input Timing

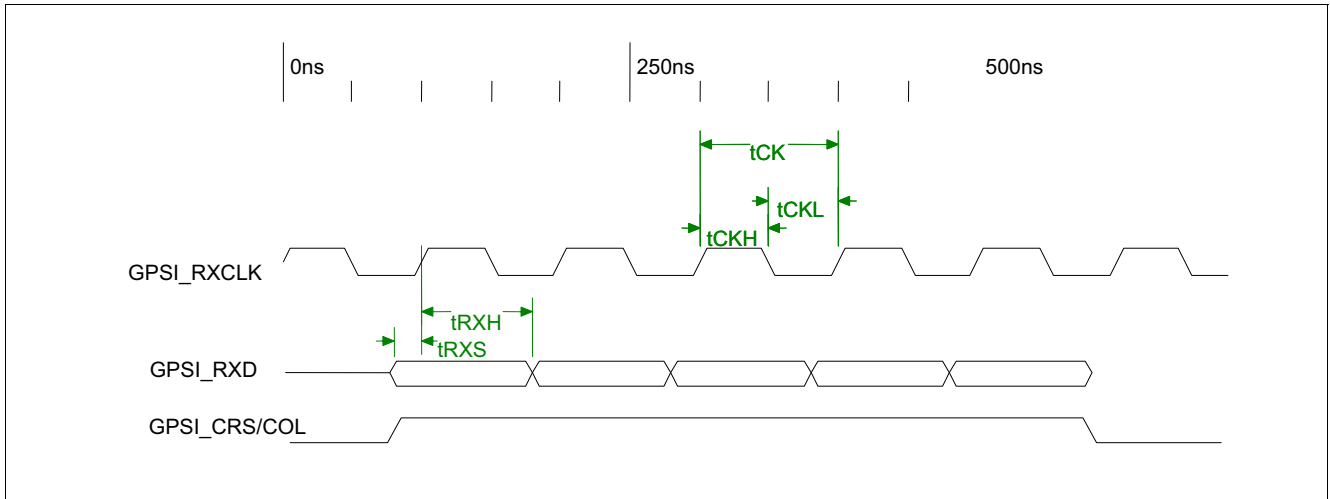

Figure 29 GPSI (7-wire) Input Timing

Table 71 GPSI (7-wire) Input Timing

Parameter	Symbol	Values			Unit	Note / Test Condition
		Min.	Typ.	Max.		
GPSI_RXCLK Period	t_{CK}	–	100	–	ns	–
GPSI_RXCLK Low Period	t_{CKL}	40	–	60	ns	–
GPSI_RXCLK High Period	t_{CKH}	40	–	60	ns	–
GPSI_RXD, GPSI_CRD/COL to GPSI_RXCLK Rising Setup Time	t_{RXS}	10	–	–	ns	–
GPSI_RXD, GPSI_CRD/COL to GPSI_RXCLK Rising HoldTime	t_{RXH}	10	–	–	ns	–

6.3.12 GPSI (7-wire) Output Timing

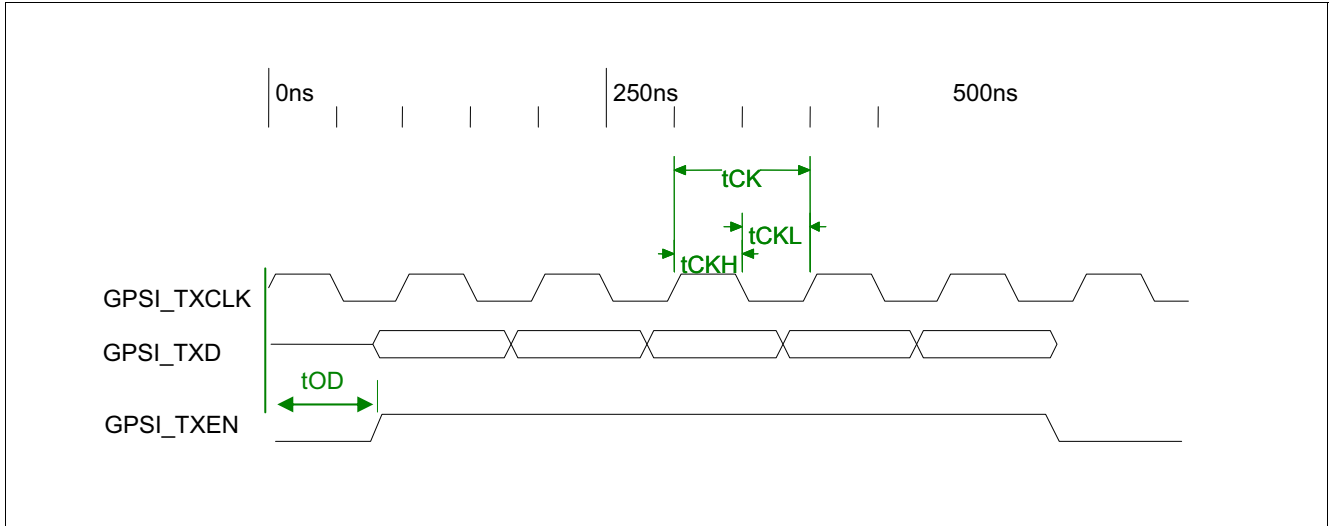

Figure 30 GPSI (7-wire) Output Timing

Table 72 GPSI (7-wire) Output Timing

Parameter	Symbol	Values			Unit	Note / Test Condition
		Min.	Typ.	Max.		
GPSI_TXCLK Period	t_{CK}	–	100	–	ns	–
GPSI_TXCLK Low Period	t_{CKL}	40	–	60	ns	–
GPSI_TXCLK High Period	t_{CKH}	40	–	60	ns	–
GPSI_TXCLK Rising to GPSI_TXEN/GPSI_TXD Output Delay	t_{OD}	50	–	70	ns	–

6.3.13 SDC/SDIO Timing

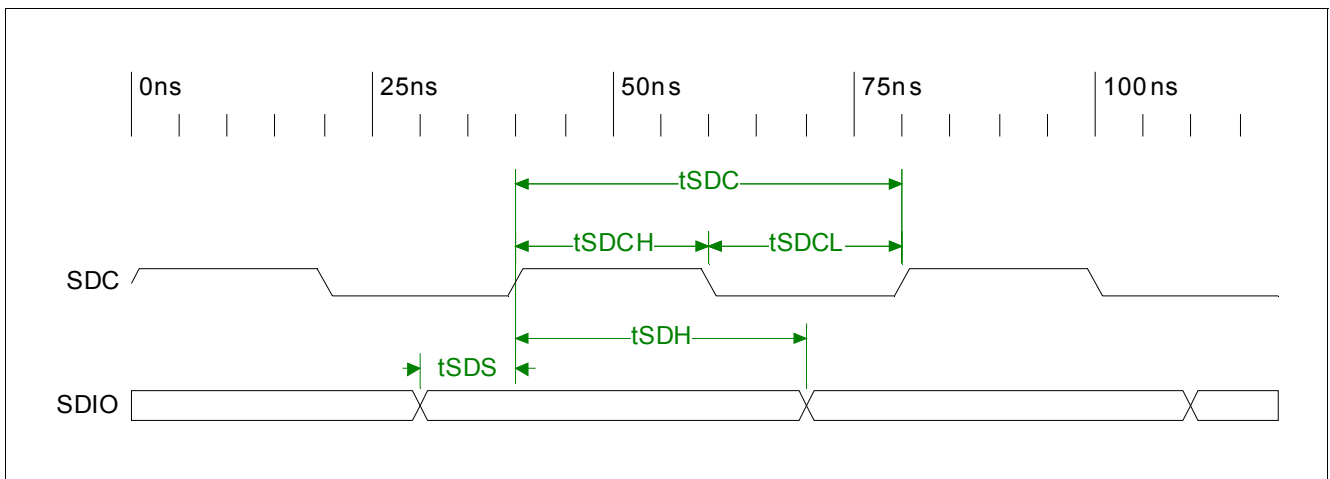

Figure 31 SDC/SDIO Timing

Table 73 SDC/SDIO Timing

Parameter	Symbol	Values			Unit	Note / Test Condition
		Min.	Typ.	Max.		
SDC Period	t_{CK}	20	–	–	ns	–
SDC Low Period	t_{CKL}	10	–	–	ns	–
SDC High Period	t_{CKH}	10	–	–	ns	–
SDIO to SDC rising setup time on read/write cycle	t_{SDS}	4	–	–	ns	–
SDIO to SDC rising hold time on read/write cycle	t_{SDH}	2	–	–	ns	–

6.3.14 MDC/MDIO Timing

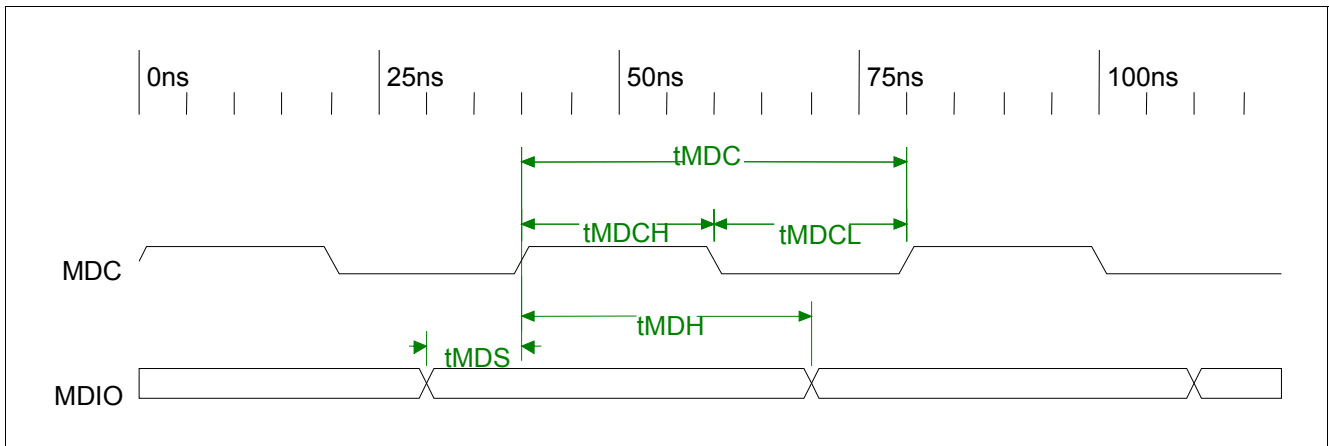

Figure 32 MDC/MDIO Timing

Table 74 MDC/MDIO Timing

Parameter	Symbol	Values			Unit	Note / Test Condition
		Min.	Typ.	Max.		
MDC Period	t_{MDC}	100	–	–	ns	–
MDC Low Period	t_{MDCL}	40	–	–	ns	–
MDC High Period	t_{MDCH}	40	–	–	ns	–
MDIO to MDC rising setup time on read/write cycle	t_{MDS}	–	–	10	ns	–
MDIO to MDC rising hold time on read/write cycle	t_{MDH}	10	–	–	ns	–

7 Package Outlines

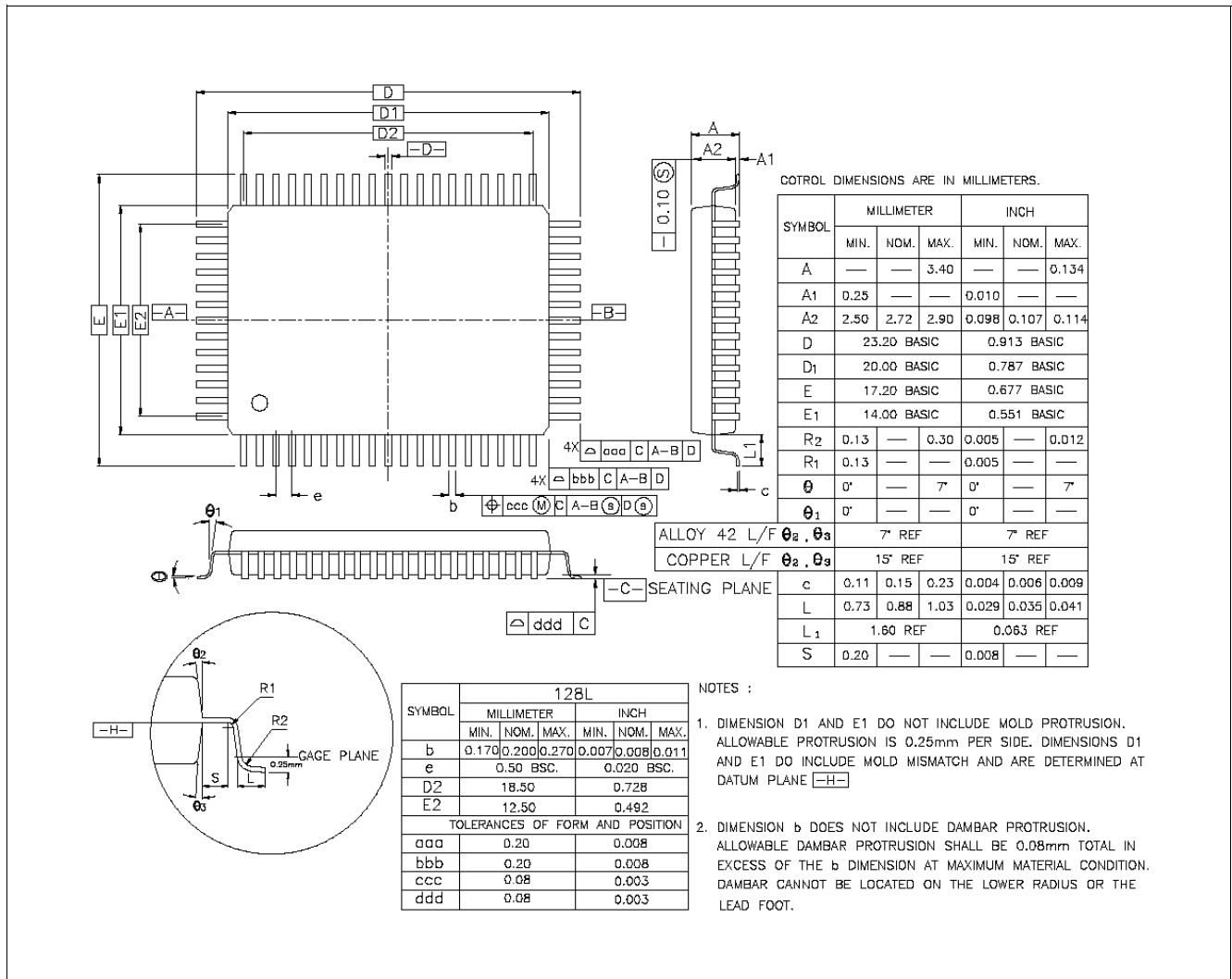

Figure 33 P-PQFP-128 Outside Dimension

7.1 Package Information

Product Name	Product Type	Package
6-Port 10/100 Mbit/s Single Chip Ethernet Switch Controller	Samurai, ADM6996FC/FCX/FHX-AD-T-1, Version AD	P-PQFP-128

Terminology

B

BER Bit Error Rate

C

CFI Canonical Format Indicator

COL Collision

CRC Cyclic Redundancy Check

CRS Carrier Sense

CS Chip Select

D

DA Destination Address

DI Data Input

DO Data Output

E

EDI EEPROM Data Input

EDO EEPROM Data Output

EECS EEPROM Chip Select

EESK EEPROM Clock

ESD End of Stream Delimiter

F

FEFI Far End Fault Indication

FET Field Effect Transistor

FLP Fast Link Pulse

G

GND Ground

GPSI General Purpose Serial Interface

I

IPG Inter-Packet Gap

L

LF SR Linear Feedback Shift Register

M

MAC Media Access Controller

MDIX MDI Crossover

MII Media Independent Interface

N

NRZI Non Return to Zero Inverter

NRZ Non Return to Zero

P

PCS Physical Coding Sub-layer

PHY Physical Layer

PLL Phase Lock Loop

PMA Physical Medium Attachment

PMD	Physical Medium Dependent
Q	
QoS	Quality of Service
QFP	Quad Flat Package
R	
RST	Reset
RXCLK	Receive Clock
RXD	Receive Data
RXDV	Receive Data Valid
RXER	Receive Data Errors
RXN	Receive Negative (Analog receive differential signal)
RXP	Receive Positive (Analog receive differential signal)
S	
SA	Source Address
SOHO	Small Office Home Office
SSD	Start of Stream Delimiter
SQE	Signal Quality Error
T	
TOS	Type of Service
TP	Twisted Pair
TTL	Transistor Logic
TXCLK	Transmission Clock
TXD	Transmission Data
TXEN	Transmission Enable
TXN	Transmission Negative
TXP	Transmission Positive

www.infineon.com